

Five Band GSM with GPS Antenna

MODEL: GAF-5

This document provides a five-band GSM + GPS Antenna design;
this simulation is for wireless LAN .



Application:

The application shall apply for antenna unit which shall be used for AVL or Fleet Management antenna systems. The combination of High Gain GPS antenna and a low profile covert GSM antenna is highly ideal for these applications that require durability, small in size, covert installation and rugged construction.

SPECIFICATIONS:

Physical Condition	
Dimension	45mm (L) x 45mm (W) x 14mm (H)
Weight	50 grams (excluding cable & connector)
Environmental Conditions	
Operation temperature	-40°C to +85°C
Storage temperature	-40°C to +100°C
Relative Humidity	95% non-condensing
Cable & Connector	
Cable	5 meter RG174/U (standard) cable, other length available
Connector Available	BNC,TNC,FME (to be adapted), GT5, MCX (OSX), SMA, SMB or SMC in straight or right angle
Optional Adapters	Universal Connector Adapter (FME to TNC/BNC/SMA/SMB/MCX)
Antenna Element	
Center Frequency	1575.42 MHz +/-1.023MHz
Polarization	R.H.C.P. (Right Handed Circular Polarization)
Absolute Gain @ Zenith	3 dBic Typ.
Gain	90° : 2.0dBi min. 20° : -5.0dBi min. Mounted on the 60mm x 60mm square ground plane
Axial Ratio	90° : 3 .0dB max. Mounted on the 60mm x 60mm square ground plane

Center Frequency	1575.42 MHz +/- 1.023 MHz
Gain	28+/-4.5dB
Bandwidth	10 MHz min. @S11≤-10 dB
Noise Figure	1.5dB Typ.
Filter	25dB @ fo± 50MHz
	35dB @ fo± 100MHz
	* fo=1575.42MHz
Supply Voltages	2.5 ~5.5V DC
Current Consumption	2.5V : 6.6mA Typ.
	3V: 8.6mA Typ.
	4V: 12.6mA Typ.
	5V: 16.6mA Typ.
Output Impedance	50 ohm
Output VSWR	2.0 max.

Overall Performance (Antenna Element, LNA & Cable)

Frequency range	1575.42 +/- 1.023 MHz
Gain	At 90° 30 ± 4.5dBi-(cable loss) Note:1 Mounted on the 60mm x 60mm square ground plane
Output Impedance	50 ohm
VSWR	2.0 max.

GSM / CDMA / 3G / WIFI

Frequency	850/900/1800/1900/2170/2400
VSWR	
824MHz	
960MHz	
1710MHz	<2.0
1990MHz	
1922MHz	
2170MHz	
2400Mhz	
Impedence	50Ω
Cable type	RG174
Cable length	5M
Connector	SMA Coding or Others
Test Portion	>3KG

NO.	NAME	FINISH	Q, TY
01	Head top	Black	01
02	Twin adhesive	Red	01
03	Rubber washer	Black	01
04	RG-174A/U Cable	Black	02
05	SMA 180° (Male)	Nickel plating	02
06	FME 180° (Female)	Nickel plating	02
07	Heat-shrink tube	Black	02
08	Label		02

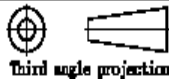
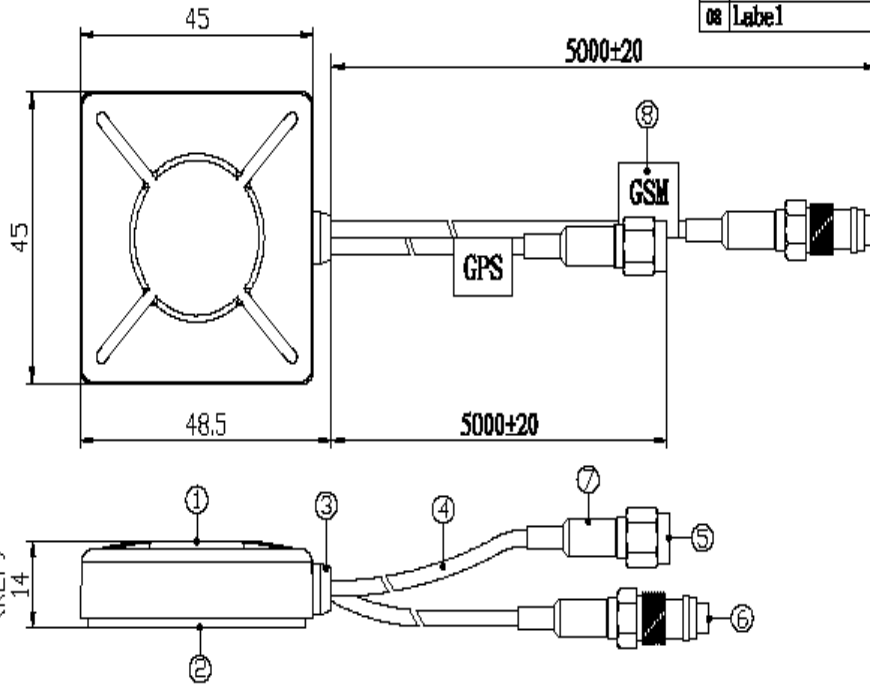

CUSTOMER'S	MODEL	PARTS NUMBER	FREQUENCY	UNIT	SCALE	DATE	VERSION
		GPS: 1575.42MHz GSM: 824-893/1710-1880/2100MHz		M/M		20071012	1

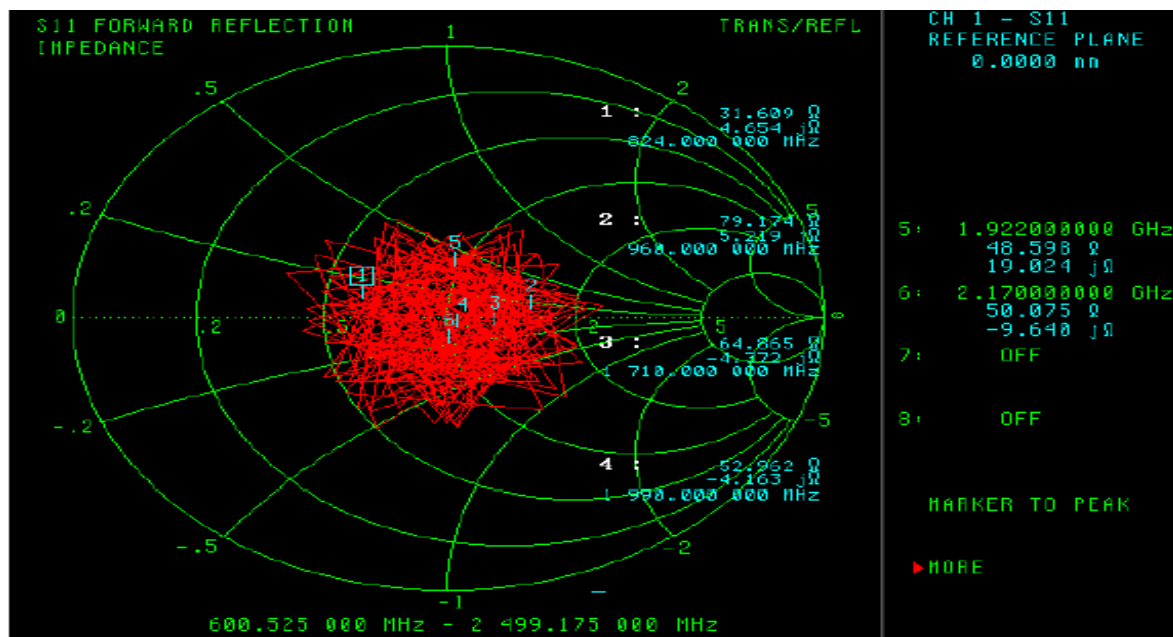
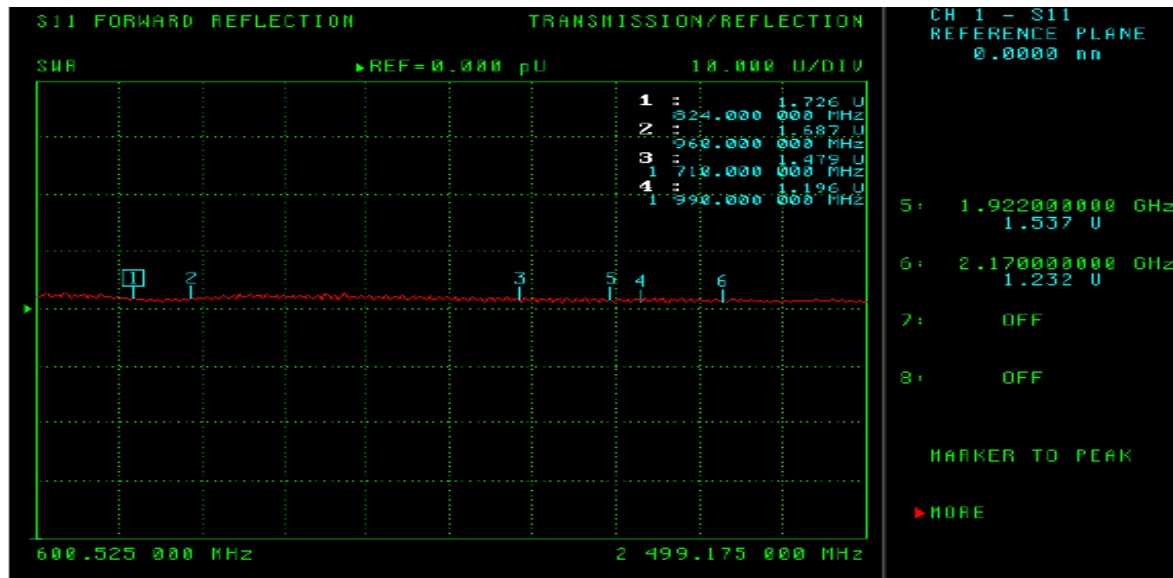
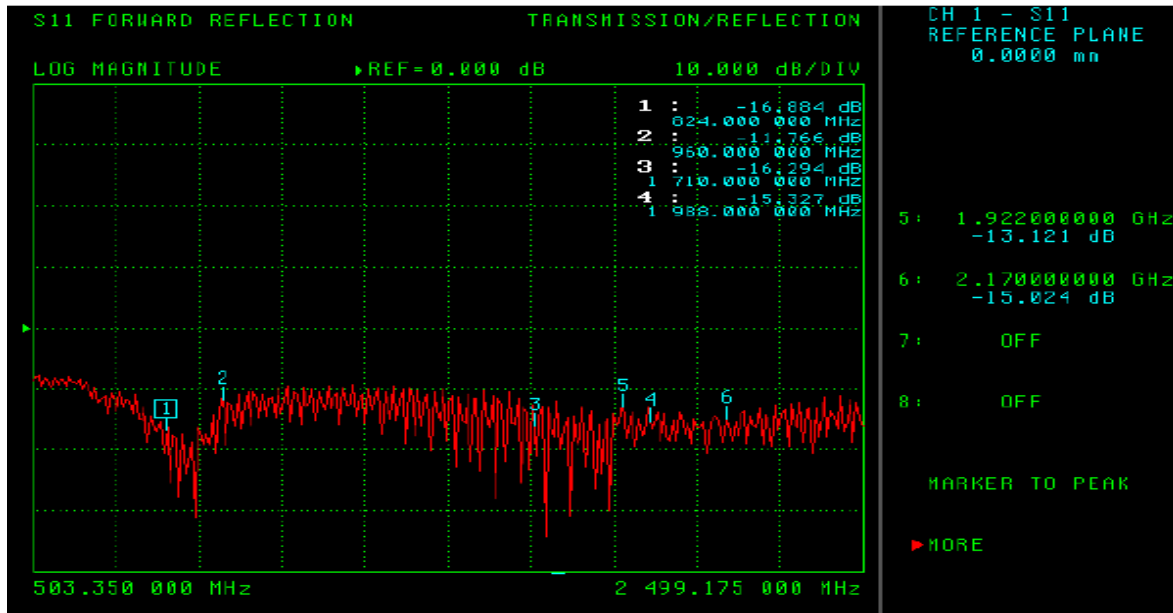

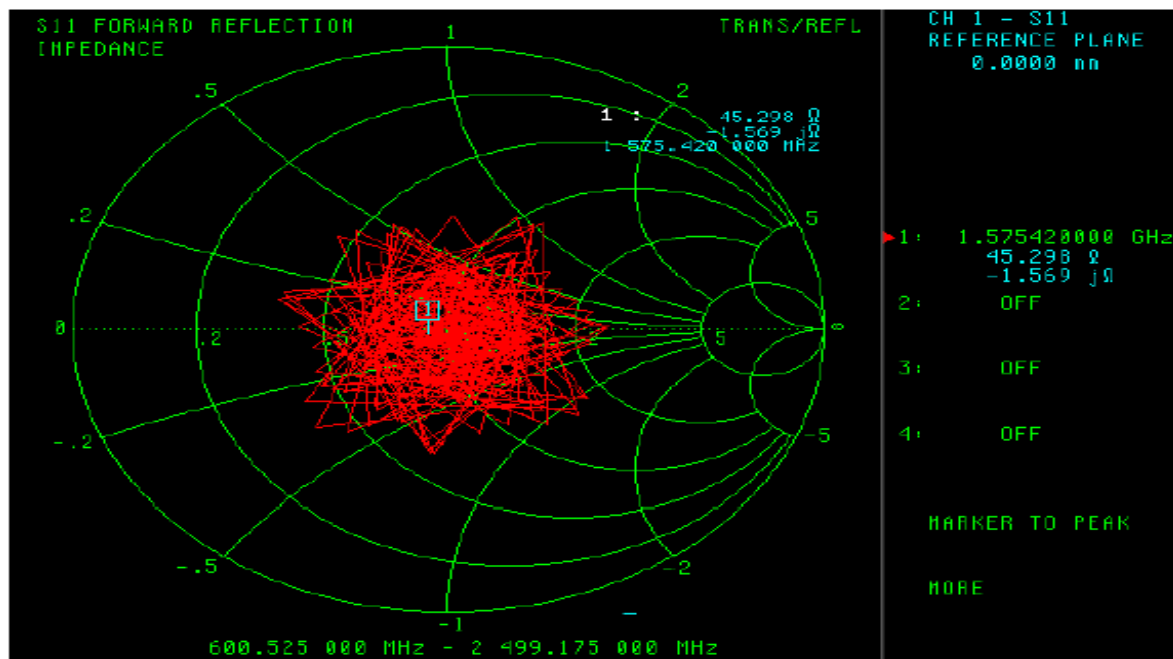
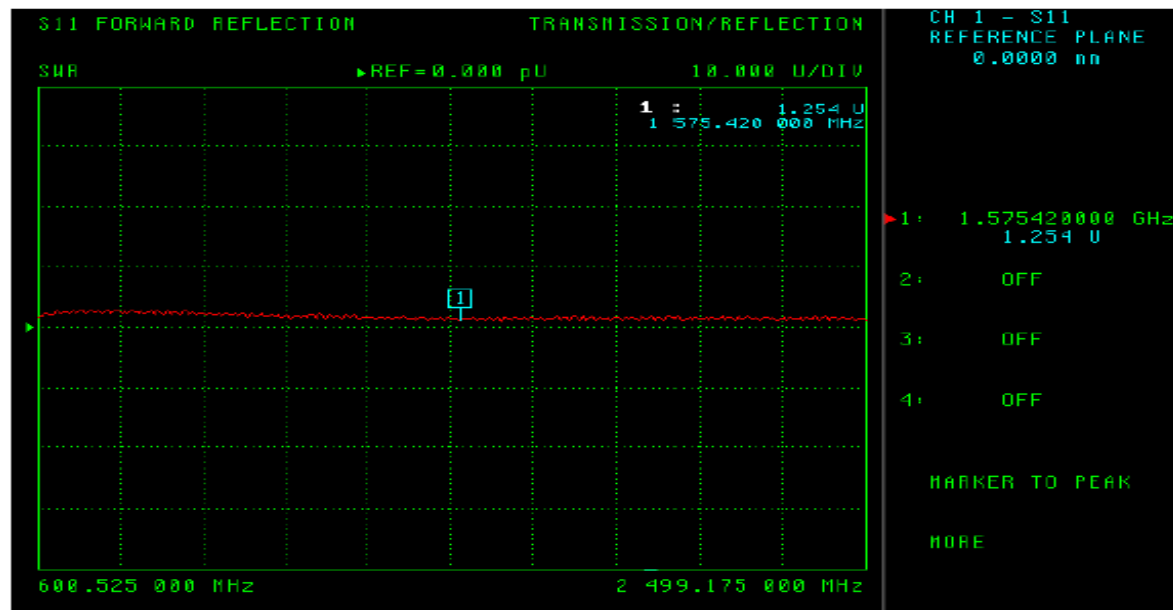
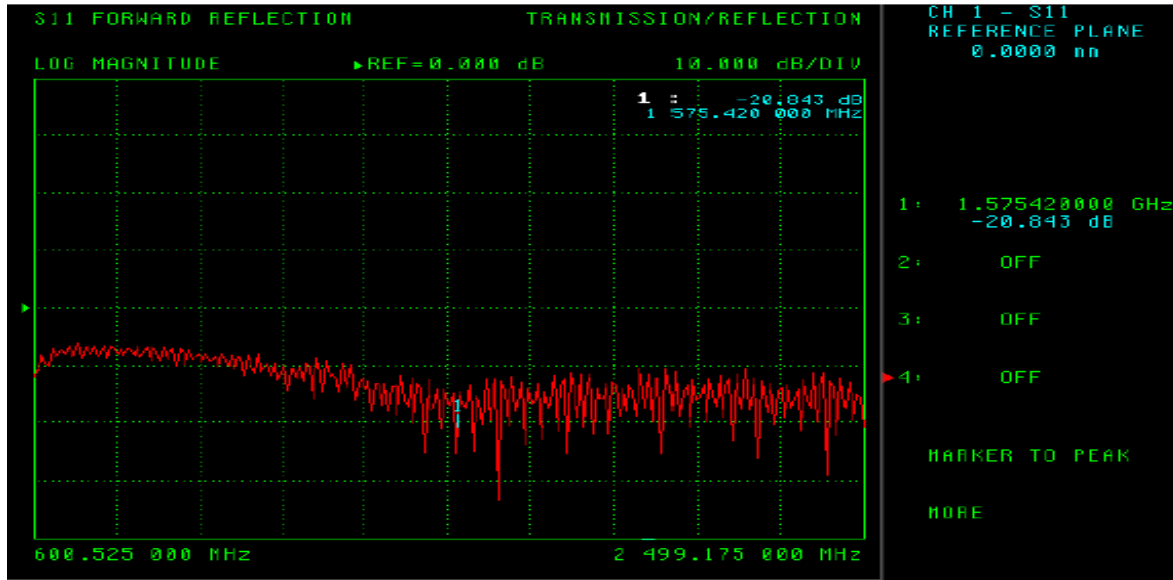

This specification is subject to change without prior notice.

Far-field amplitude of GAF-5.nsi

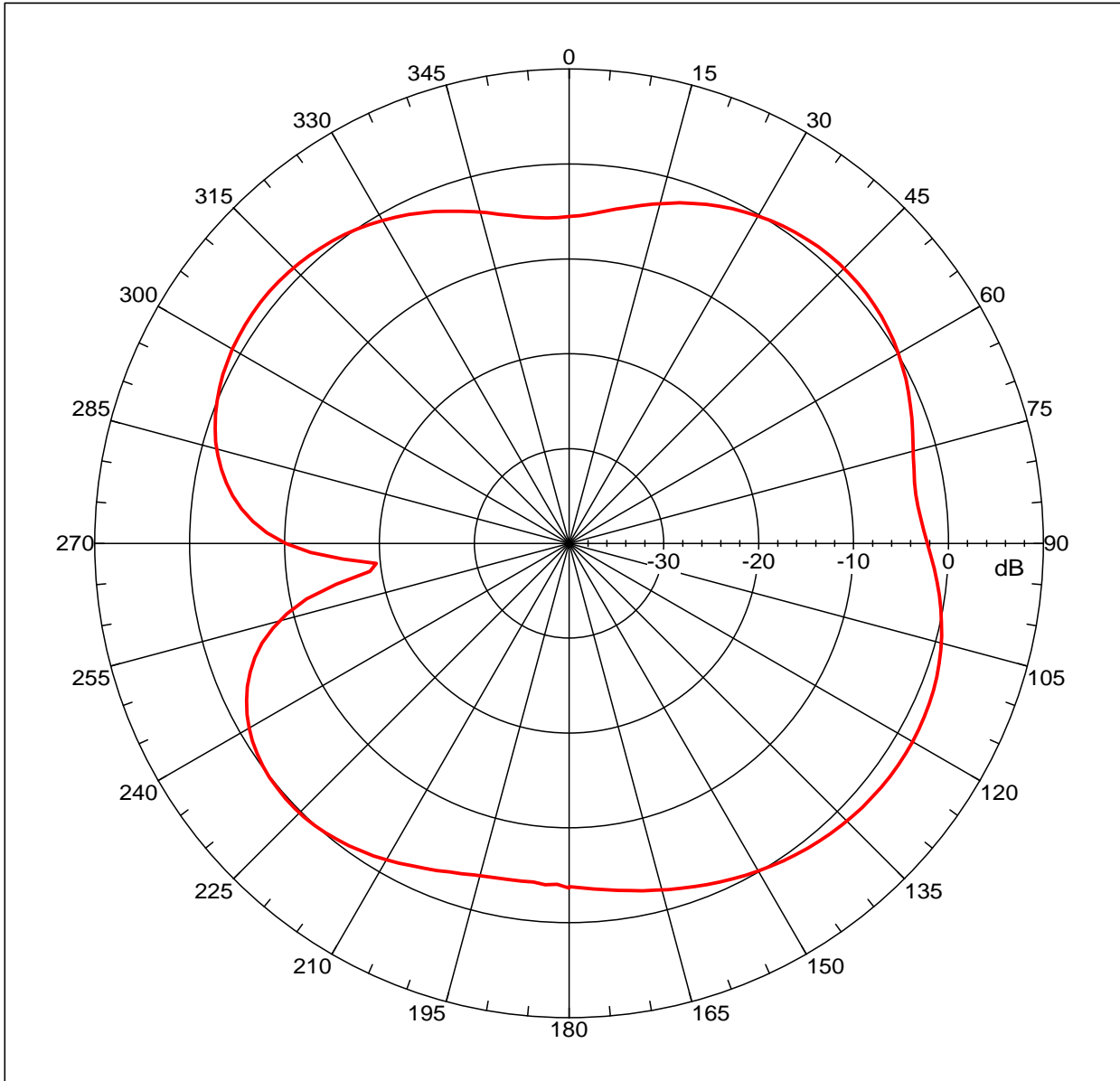

Far-field amplitude, Eprincipal: Linear, Tau = 0.000 deg
Gain = 1.84674 dBi
Max far-field (global) = -41.1526 dB, Max far-field (plot) = -41.15263 dB
Normalization: Reference, Network offset = 0.000 dB
Hpeak at: 121.99999 deg, Vpeak at: 0.000 deg
Plot centering: On

MP-5180mm 2007/5/8H-Plane cut scan. Feeding cable at bottom side around RJC been covered by absorber to reduce possible coupling with AUT.

NSI2000 V4.0.124, Filename:C:\nsi2000\steven\GAF5.nsi
Measurement date/time: 5/8/2009 4:24:44 PM, Filetype: NSI-97
Far-field Cut Analysis:
Avg value: -1.386 dB
-3. dB beam width: 62.71 deg
-6. dB beam width: Not Found
-10. dB beam width: Not Found
Left Sidelobe: -0.87 dB at 45.251 deg
Right Sidelobe: Not Found
Far-field display setup
Azimuth (deg)
Span = 360.00001 deg, Center = 0.000 deg, #pts = 181
Start = -180.00001 deg, Stop = 180.00001 deg, Delta = 2.000 deg
Elevation (deg)
Center = 0.000 deg, #pts = 1

Selected beam(s) 1 of 6

Beam	Frequency	Azimuth	Elevation	Pol
1	0.824 GHz	Azimuth	Elevation	Single-pol

Far-field amplitude of GAF-5.nsi

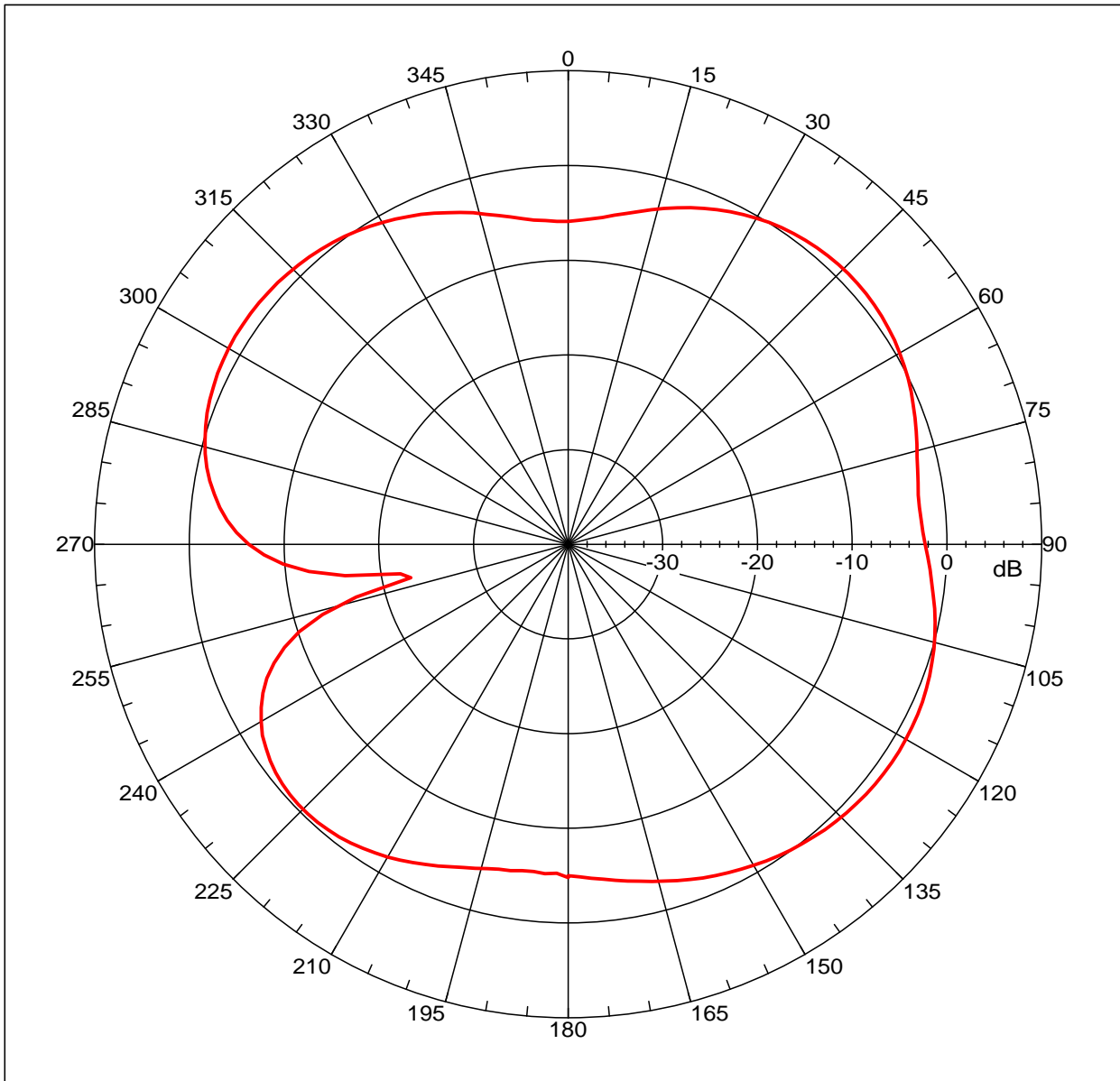

Far-field amplitude, Eprincipal: Linear, Tau = 0.000 deg
Gain = 1.4378 dBi
Max far-field (global) = -40.4029 dB, Max far-field (plot) = -40.40291 dB
Normalization: Reference, Network offset = 0.000 dB
Hpeak at: -54.000 deg, Vpeak at: 0.000 deg
Plot centering: On

MP-5180mm 2007/5/8H-Plane cut scan. Feeding cable at bottom side around RJC been covered by absorber to reduce possible coupling with AUT.

NSI2000 V4.0.124, Filename:C:\nsi2000\steven\GAF-5.nsi
Measurement date/time: 5/8/2009 4:24:44 PM, Filetype: NSI-97
Far-field Cut Analysis:
Avg value: -1.631 dB
-3. dB beam width: 54.43 deg
-6. dB beam width: 75.86 deg
-10. dB beam width: Not Found
Left Sidelobe: -1.87 dB at -133.743 deg
Right Sidelobe: -0.32 dB at 49.274 deg
Far-field display setup
Azimuth (deg)
Span = 360.00001 deg, Center = 0.000 deg, #pts = 181
Start = -180.00001 deg, Stop = 180.00001 deg, Delta = 2.000 deg
Elevation (deg)
Center = 0.000 deg, #pts = 1

Selected beam(s) 1 of 6

Beam	Frequency	Azimuth	Elevation	Pol
2	0.842 GHz	Azimuth	Elevation	Single-pol

Far-field amplitude of GAF-5.nsi

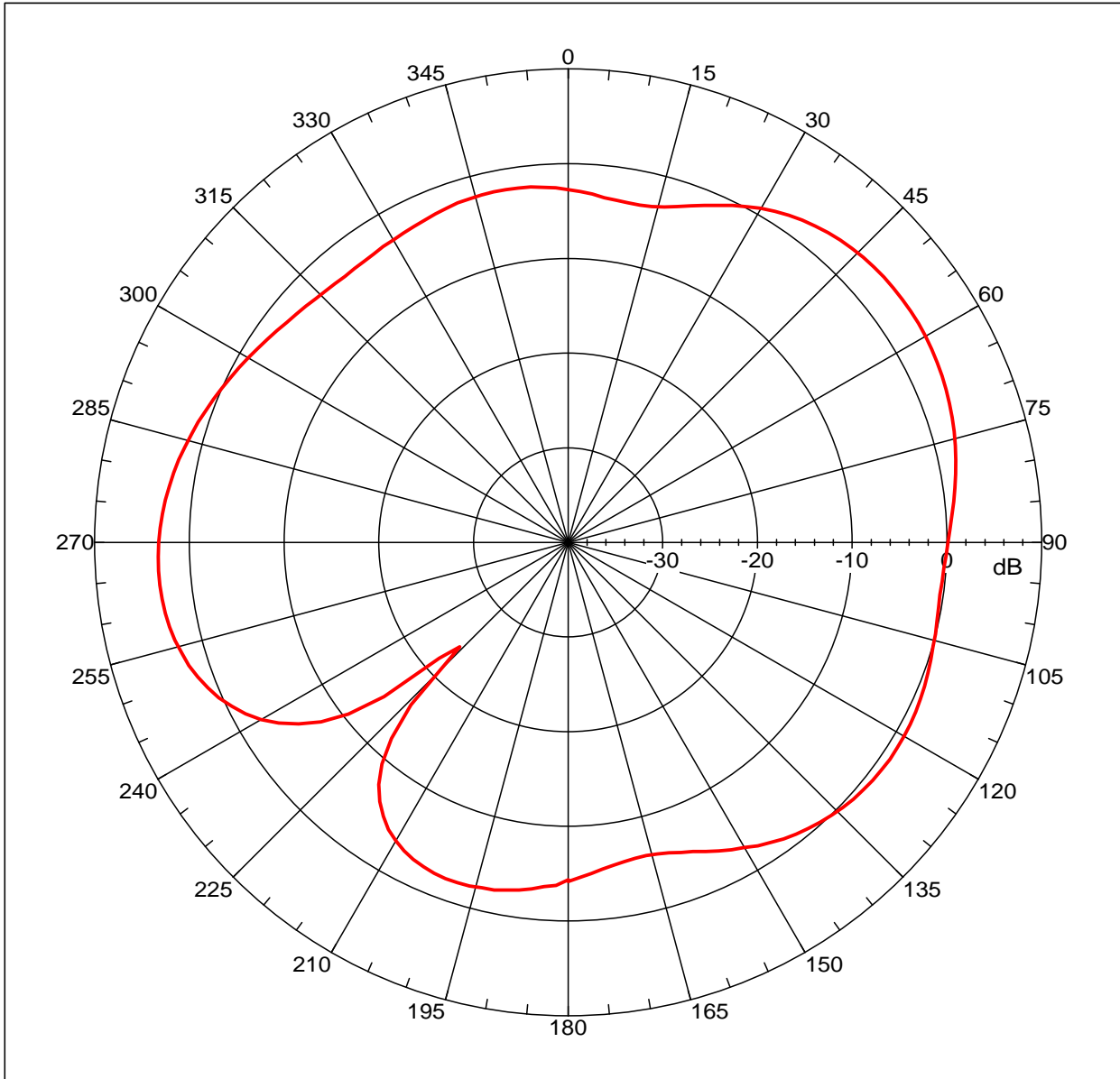

Far-field amplitude, Eprincipal: Linear, Tau = 0.000 deg
Gain = 3.62634 dBi
Max far-field (global) = -39.00333 dB, Max far-field (plot) = -39.00333 dB
Normalization: Reference, Network offset = 0.000 dB
Hpeak at: 55.99999 deg, Vpeak at: 0.000 deg
Plot centering: On

MP-5180mm 2007/5/8H-Plane cut scan. Feeding cable at bottom side around RJC been covered by absorber to reduce possible coupling with AUT.

NSI2000 V4.0.124, Filename:C:\nsi2000\steven\GAF5.nsi
Measurement date/time: 5/8/2009 4:24:44 PM, Filetype: NSI-97
Far-field Cut Analysis:
Avg value: -0.704 dB
-3. dB beam width: 56.49 deg
-6. dB beam width: 130.03 deg
-10. dB beam width: Not Found
Left Sidelobe: -5.79 dB at -11.061 deg
Right Sidelobe: -2.65 dB at 125.698 deg
Far-field display setup
Azimuth (deg)
Span = 360.00001 deg, Center = 0.000 deg, #pts = 181
Start = -180.00001 deg, Stop = 180.00001 deg, Delta = 2.000 deg
Elevation (deg)
Center = 0.000 deg, #pts = 1

Selected beam(s) 1 of 6

Beam	Frequency	Azimuth	Elevation	Pol
3	0.960 GHz	Azimuth	Elevation	Single-pol

Far-field amplitude of GAF-5.nsi

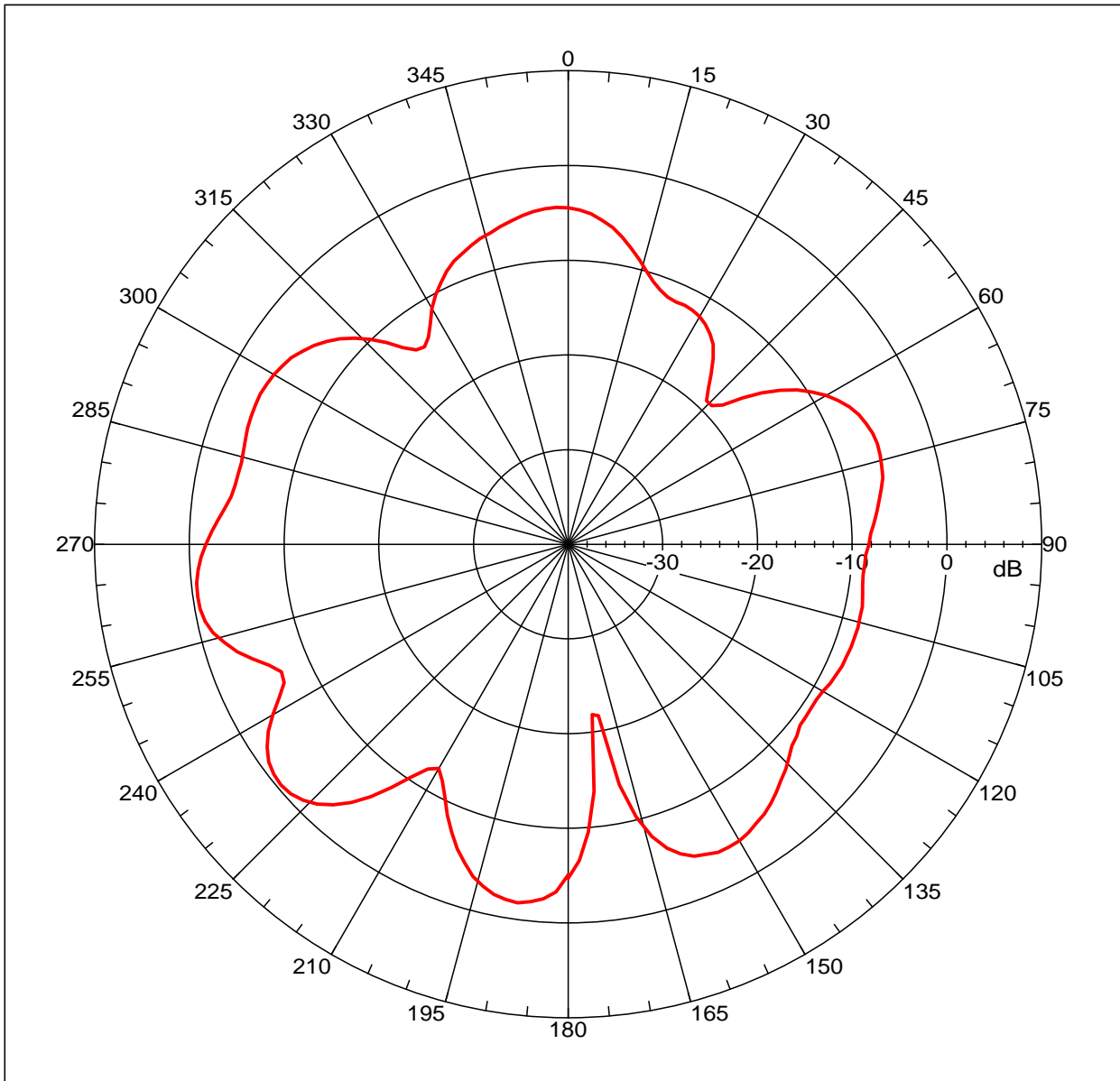

Far-field amplitude, Eprincipal: Linear, Tau = 0.000 deg
 Gain = -0.43368 dBi
 Max far-field (global) = -45.7983 dB, Max far-field (plot) = -45.79843 dB
 Normalization: Reference, Network offset = 0.000 dB
 Hpeak at: -130.000 deg, Vpeak at: 0.000 deg
 Plot centering: On

MP-5180mm 2007/5/8H-Plane cut scan. Feeding cable at bottom side around RJC been covered by absorber to reduce possible coupling with AUT.

NSI2000 V4.0.124, Filename:C:\nsi2000\steven\GAF5.nsi
 Measurement date/time: 5/8/2009 4:24:44 PM, Filetype: NSI-97
 Far-field Cut Analysis:
 Avg value: -6.330 dB
 -3. dB beam width: 17.87 deg
 -6. dB beam width: 26.05 deg
 -10. dB beam width: 103.42 deg
 Left Sidelobe: -1.33 dB at -171.955 deg
 Right Sidelobe: -0.09 dB at -97.542 deg
 Far-field display setup
 Azimuth (deg)
 Span = 360.00001 deg, Center = 0.000 deg, #pts = 181
 Start = -180.00001 deg, Stop = 180.00001 deg, Delta = 2.000 deg
 Elevation (deg)
 Center = 0.000 deg, #pts = 1

Selected beam(s) 1 of 6

Beam	Frequency	Azimuth	Elevation	Pol
4	1.710 GHz	Azimuth	Elevation	Single-pol

Far-field amplitude of GAF-5.nsi

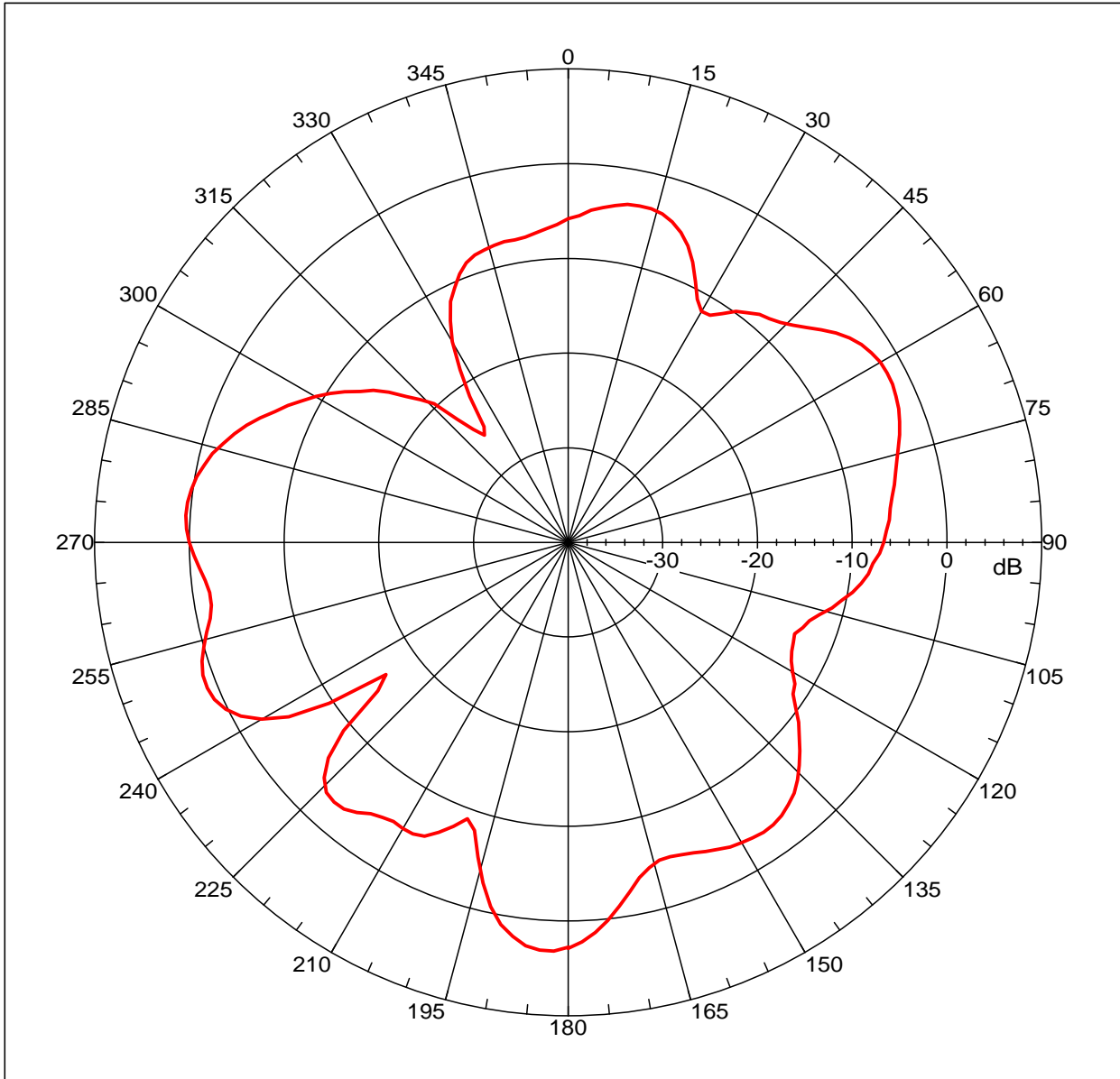

Far-field amplitude, Eprincipal: Linear, Tau = 0.000 deg
Gain = 3.19039 dBi
Max far-field (global) = -43.89702 dB, Max far-field (plot) = -43.89722 dB
Normalization: Reference, Network offset = 0.000 dB
Hpeak at: -178.000 deg, Vpeak at: 0.000 deg
Plot centering: On

MP-5180mm 2007/5/8H-Plane cut scan. Feeding cable at bottom side around RJC been covered by absorber to reduce possible coupling with AUT.

NSI2000 V4.0.124, Filename:C:\nsi2000\steven\GAF5.nsi
Measurement date/time: 5/8/2009 4:24:44 PM, Filetype: NSI-97
Far-field Cut Analysis:
Avg value: -4.903 dB
-3. dB beam width: Not Found
-6. dB beam width: Not Found
-10. dB beam width: Not Found
Left Sidelobe: Not Found
Right Sidelobe: -8.30 dB at -149.832 deg
Far-field display setup
Azimuth (deg)
Span = 360.00001 deg, Center = 0.000 deg, #pts = 181
Start = -180.00001 deg, Stop = 180.00001 deg, Delta = 2.000 deg
Elevation (deg)
Center = 0.000 deg, #pts = 1

Selected beam(s) 1 of 6

Beam	Frequency	Azimuth	Elevation	Pol
5	1.900 GHz	Azimuth	Elevation	Single-pol

Far-field amplitude of GAF-5.nsi

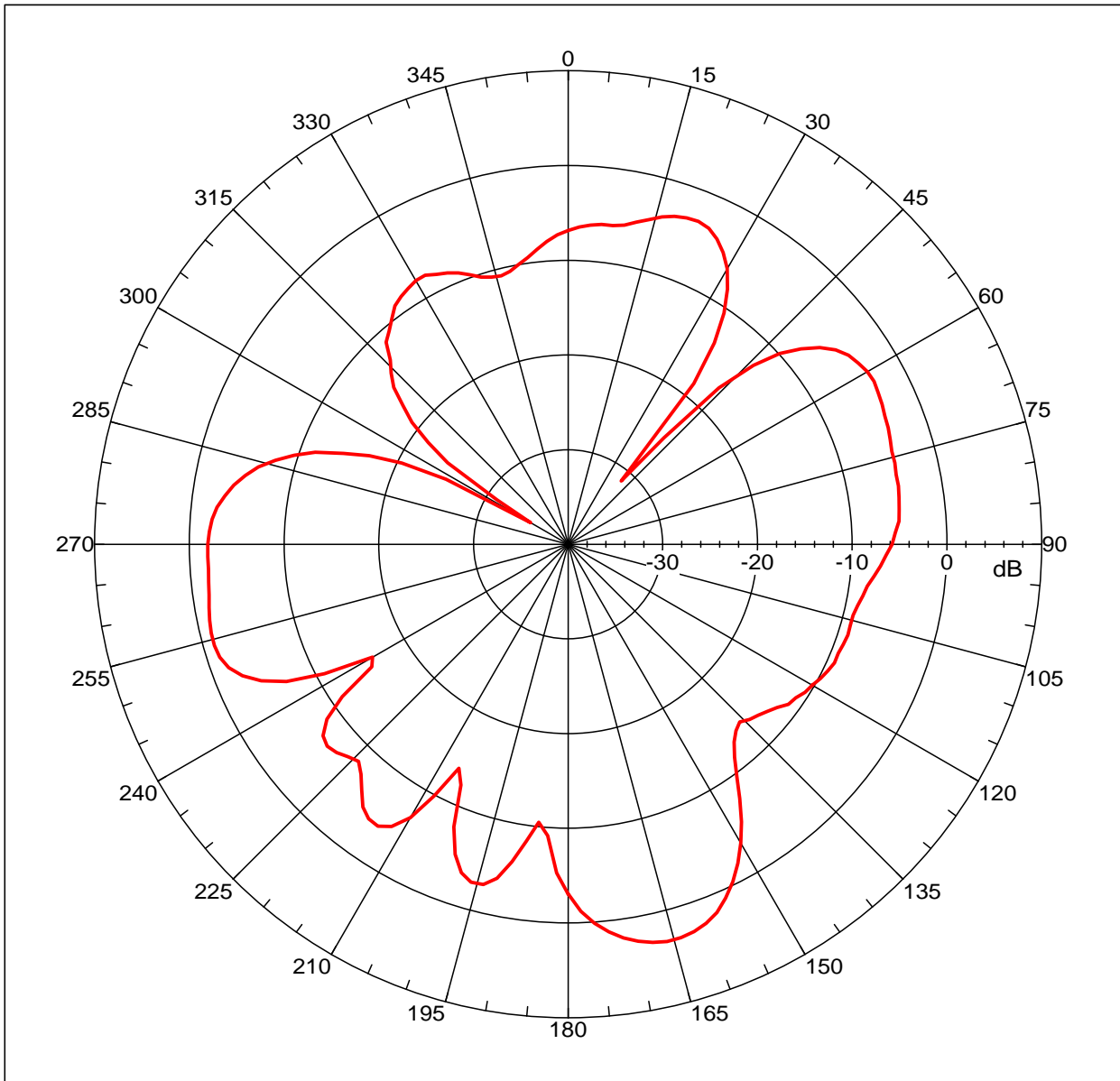

Far-field amplitude, Eprincipal: Linear, Tau = 0.000 deg
Gain = 3.2201 dBi
Max far-field (global) = -44.3623 dB, Max far-field (plot) = -44.3626 dB
Normalization: Reference, Network offset = 0.000 dB
Hpeak at: 165.99999 deg, Vpeak at: 0.000 deg
Plot centering: On

MP-5180mm 2007/5/8H-Plane cut scan. Feeding cable at bottom side around RJC been covered by absorber to reduce possible coupling with AUT.

NSI2000 V4.0.124, Filename: C:\nsi2000\steven\GAF5.nsi
Measurement date/time: 5/8/2009 4:24:44 PM, Filetype: NSI-97
Far-field Cut Analysis:
Avg value: -6.030 dB
-3. dB beam width: 21.01 deg
-6. dB beam width: Not Found
-10. dB beam width: Not Found
Left Sidelobe: -12.45 dB at 115.643 deg
Right Sidelobe: Not Found
Far-field display setup
Azimuth (deg)
Span = 360.00001 deg, Center = 0.000 deg, #pts = 181
Start = -180.00001 deg, Stop = 180.00001 deg, Delta = 2.000 deg
Elevation (deg)
Center = 0.000 deg, #pts = 1

Selected beam(s) 1 of 6

Beam	Frequency	Azimuth	Elevation	Pol
6	2.170 GHz	Azimuth	Elevation	Single-pol