

Vehicle Locating & Marine Small

GPS/GLONASS/GSM Antenna

MODEL: GAF-62GL

Small size and ruggedness, demand of vehicle locating and marine navigation GPS/ GLONASS/GSM antenna that will sustain harsh environment.



- Low noise figure
- Fully weather proof IPX8 .
- Ultra-high Sensitivity
- Compact construction
- Excellent temperature stability

Specifications:

PHYSICAL CONDITION	
Constructions:	Polycarbonate radome, detachable cable/connector for easy mount, rubber-O-ring between top radome and screw base for waterproof
Dimensions:	60mm(Dia.) x 18.5mm(H)
Weight:	65grams (w/o cable & connector).
Color:	Standard in ivory white, other colours available upon request.
Mounting:	Bulkhead mount with 0.8 inch threaded wing nut (standard accessory). FB6 2.5mm SUS L-Mounting
Cable & Connector	
RF cable:	RG174-3M or 5M
Pulling strength:	6 Kg @ 5sec. molded plastic on connector end for strain relief.
Connector	SMA(M) or Others
Antenna Element	
Center Frequency:	1575Mhz & 1596-1610 MHz
Polarization:	R.H.C.P. (Right Handed Circular Polarization).
Bandwidth	10 MHz min. @S11≤-10 dB, 24MHz typ. @S11<-8dB
Gain @ 10° Elevation:	2 dBi typical.
Axial Ratio:	3 dB max.
Output VSWR:	1.5 max
Output Impedance:	50 ohm
Low Noise Amplifier	
Power Gain:	1570 Mhz : 29db typ 1610 Mhz : 29db typ

Bandwidth:	50 MHz min.
Noise Figure:	1.5 typ
Outer Band Attenuation:	20 dB min. @ Fo +/-50 Mhz.
Supply Voltages:	2.3~5.5V DC.
Current Consumption:	2.5V : 6.6mA Typ. 3V : 10.6mA Typ. 4V : 14.6mA Typ. 5V : 20.6mA Typ.
Output Impedance:	50W ohm
Overall Performance: (antenna element, LNA & coax cable)	
Center Frequency:	1570 ~1610 Mhz.
Gain:	At 90° vertical to sky 30 ± 4.5dBi (cable loss) Note:1 Mounted on the 60mm x 60mm square ground plane
Noise Figure:	2.0 max.
Axial Ratio:	3 dB max.
Bandwidth:	10MHz min.
VSWR:	2.0 max.
Output Impedance:	50W ohm
Environmental	
Operating Temperature:	-40°C~ +85°C.
Storage Temperature:	-40°C~ +90°C.
Relative Humidity:	95% non-condensing.
Water Resistance:	100% waterproof.
GSM / CDMA / 3G /2.4G	
Frequency	850/900/1800/1900/2170/2.4G
VSWR	2.0
Impedence	50Ω
Cable type	RG174
Cable length	3M or 5M
Connector	SMA(M) or Others

* This specification is subject to change without prior notice

Data Updated: Jan.11, 2010



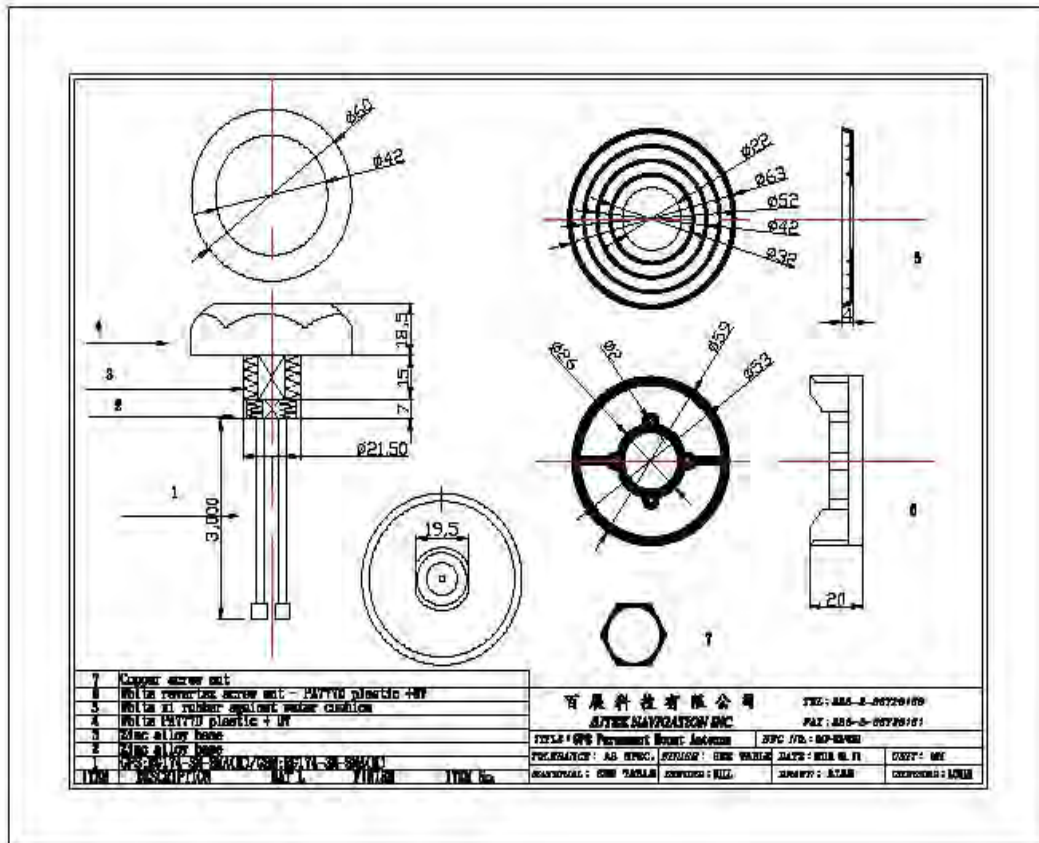

SUS L-Mounting

Madel : FB-6



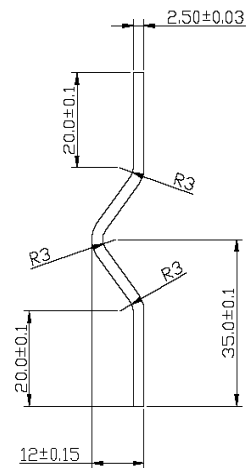
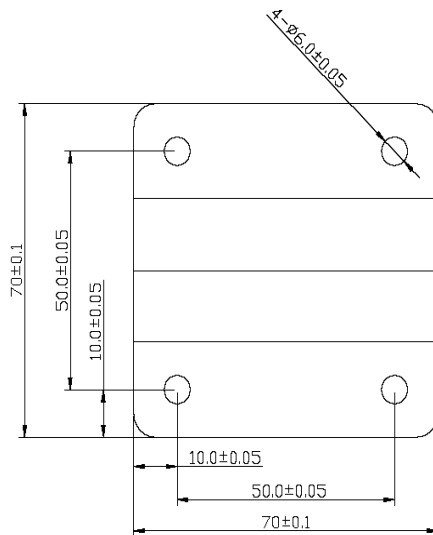
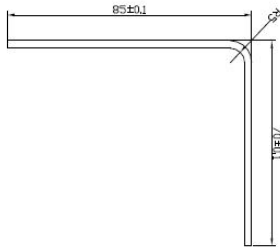
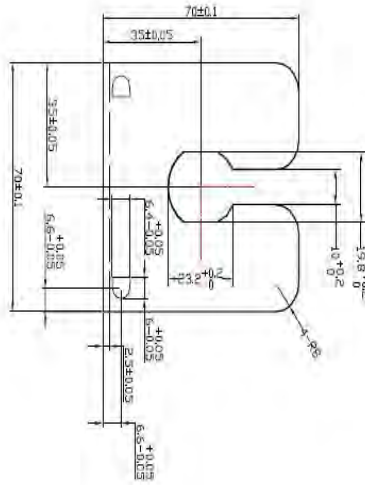
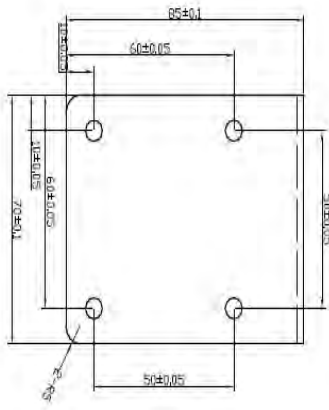

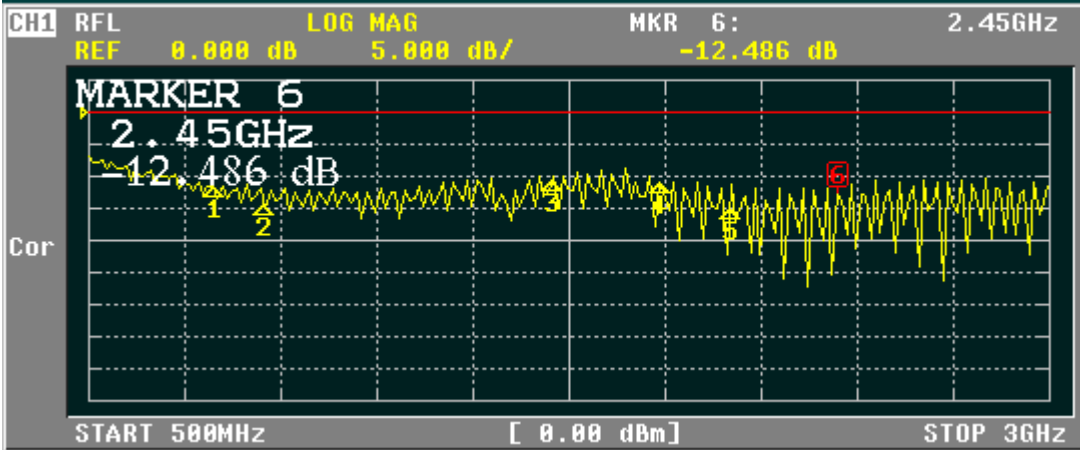

MARKER

MARKER 6

MARKER 7

MARKER 8

MARKER 9

MARKER 10

ACTIVATE MKR OFF

Return

More 2/2

CH1 MARKER LIST

1:	824.000MHz	-11.662 dB
2:	960.000MHz	-14.456 dB
3:	1.710 000GHz	-10.470 dB
4:	1.990 000GHz	-11.190 dB
5:	2.170 000GHz	-15.624 dB
6:	2.450 000GHz	-12.486 dB
7:		
8:		
9:		
10:		

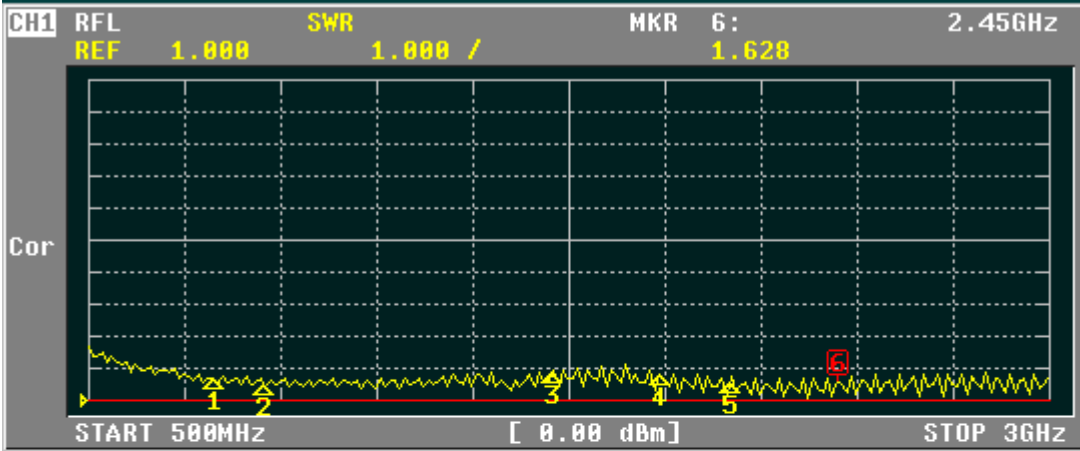

FORMAT

SWR

REAL

IMAG

PHASE -∞, +∞

LOG MAG & PHASE

LOG MAG & DELAY

LIN MAG & PHASE

More 2/2

CH1 MARKER LIST

1:	824.000MHz	1.706
2:	960.000MHz	1.477
3:	1.710 000GHz	1.867
4:	1.990 000GHz	1.767
5:	2.170 000GHz	1.525
6:	2.450 000GHz	1.628
7:		
8:		
9:		
10:		