

Vehicle Locating Small GPS/GSM/FM Antenna

MODEL: GFA-650L

Small size and ruggedness, demand of vehicle locating and car navigation GPS antenna that will sustain harsh environment.



- Low noise figure
- Fully weather proof IPX7 .
- Ultra-high Sensitivity
- Compact construction
- Excellent temperature stability

The antenna system **GFA-65L** is the integration of the high performance GPS patch antenna and a low noise amplifier into state-of-the-art low a very low profile/extremely compact/fully waterproof antenna signal enclosure. When connected to a GPS receiver with +2.5~ 5.5V DC antenna powers it provides excellent signal amplification and out-band-rejection for that receiver.

Features:

GPS antenna with double threaded bolts and through holes for cable routing with course & fine treaded pitch locking for wing-nut fastener and lock-nut to prevent vibrations and un-authorized removal.

Specifications:

PHYSICAL CONDITION	
Constructions:	Polycarbonate radome, detachable cable/connector for easy mount, rubber-O-ring between top radome and screw base for waterproof
Dimensions:	60mm(Dia.) x 45mm(H)
Weight:	65grams (w/o cable & connector).
Color:	White or Black (Optional)
Mounting:	Bulkhead mount with 0.8 inch threaded wing nut (standard accessory).
Cable & Connector	
RF cable:	RG174 -5M,
Pulling strength:	6 Kg @ 5sec. molded plastic on connector end for strain relief.
Connector available:	SMA ,SMB,Fakra ,BNC,TNC,MMCX,MCX----
Antenna Element	
Center Frequency:	1575.42 MHz +/-1.023 MHz
Polarization:	R.H.C.P. (Right Handed Circular Polarization).
Absolute Gain @ Zenith:	+5 dBi typical.
Gain @ 10° Elevation:	-1 dBi typical.
Axial Ratio:	3 dB max.
Output VSWR:	2.0
Output Impedance:	50 ohm

Center Frequency:	1575.42 +/- 1.023 MHz
Power Gain:	28 db +/-3db
Bandwidth:	10 MHz min. @S11≤-10 dB
Noise Figure:	1.5
Outer Band Attenuation:	3 dB max.
Supply Voltages:	2.5~5.5V DC.
Current Consumption:	at 2.5V 6.6mA Typ. at 3.0V 8.6mA Typ. at 4.0V 12.6mA Typ. at 5.0V 16.6mA Typ.
Filter	20dB 25dB @ fo+/- 50MHz 30dB 35dB @ fo+/- 100MHz * fo=1575.42MHz

Overall Performance: (antenna element, LNA & coax cable)

Center Frequency:	1575.42 +/- 1.023 MHz
Gain:	At 90° vertical to sky 30 ± 4.5dBi (cable loss) Note:1 Mounted on the 60mm x 60mm square ground plane
Noise Figure:	1.5 max.
Axial Ratio:	3 dB max.
Bandwidth:	10 MHz min. @S11≤-10 dB
VSWR:	2.0 max.
Output Impedance:	50 ohm

Environmental

Operating Temperature:	-40°C~ +100°C.
Storage Temperature:	-40°C~ +100°C.
Relative Humidity:	95% non-condensing.
Water Resistance:	100% waterproof.

GSM / CDMA / 3G /		FM
Frequency	850/900/1800/1900/2170	88-108Mhz
VSWR	2.0	3.5
Impedence	50Ω	
Cable type	RG174	RG174
Cable length	5M	5M
Connector	SMA Coding or Others	SMA Coding or Others

* This specification is subject to change without prior notice

Data Updated: JUL.26, 2011

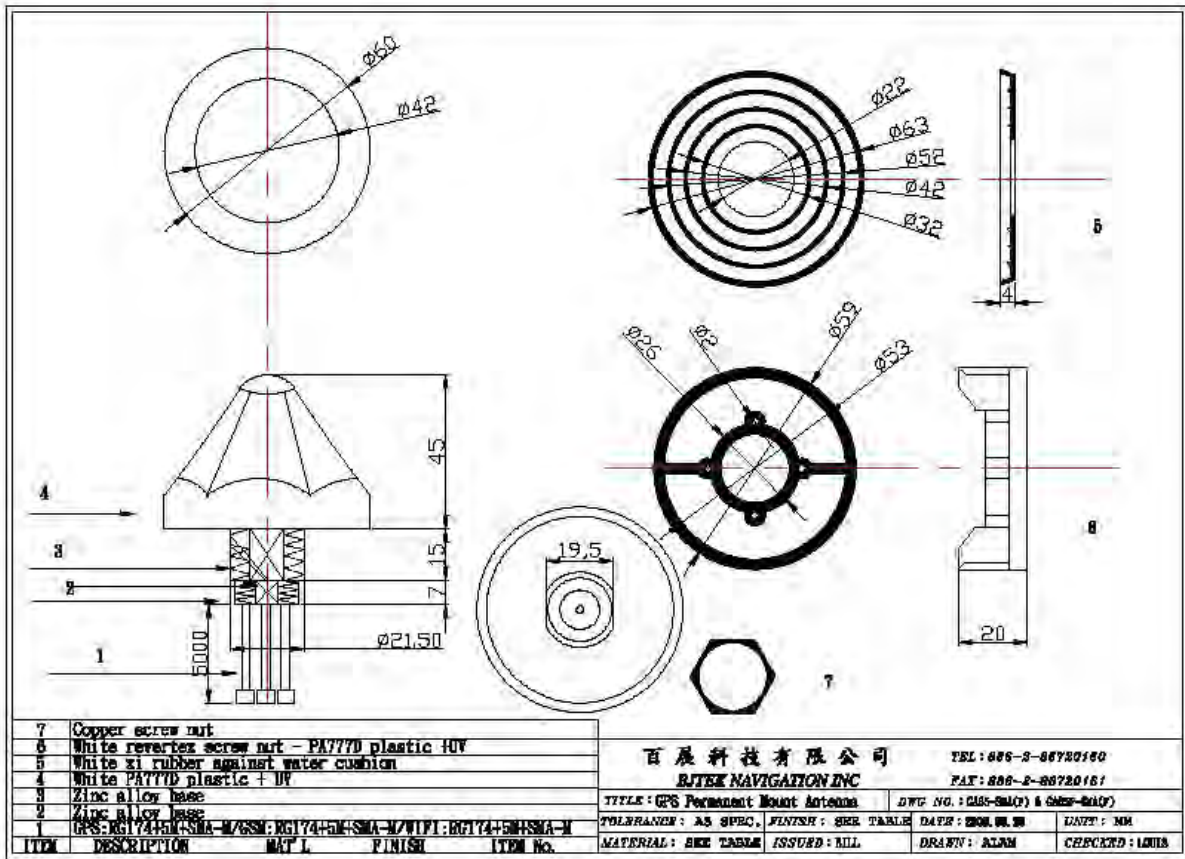

SUS L-Mounting

Madel : FB-6



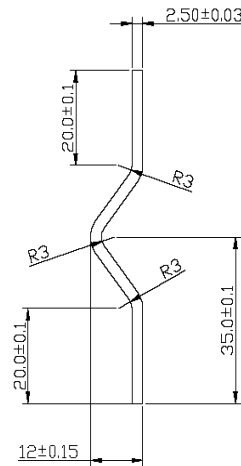
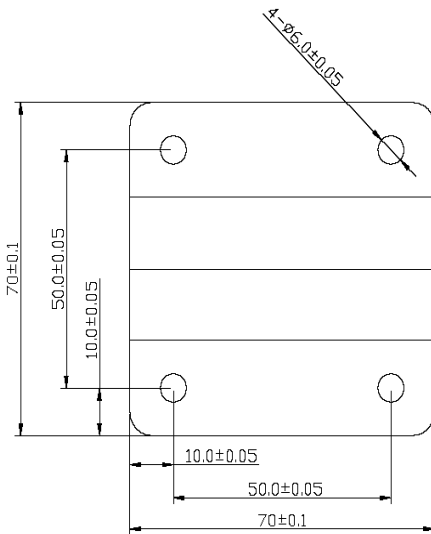
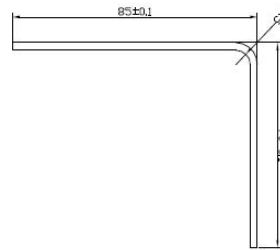
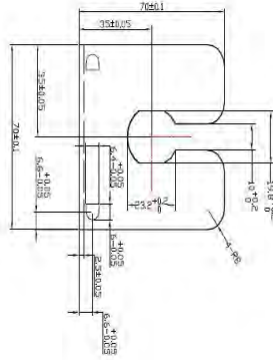
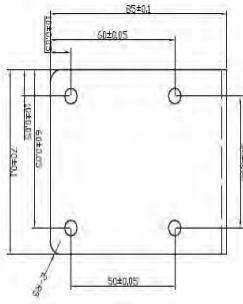

GPS TEST :

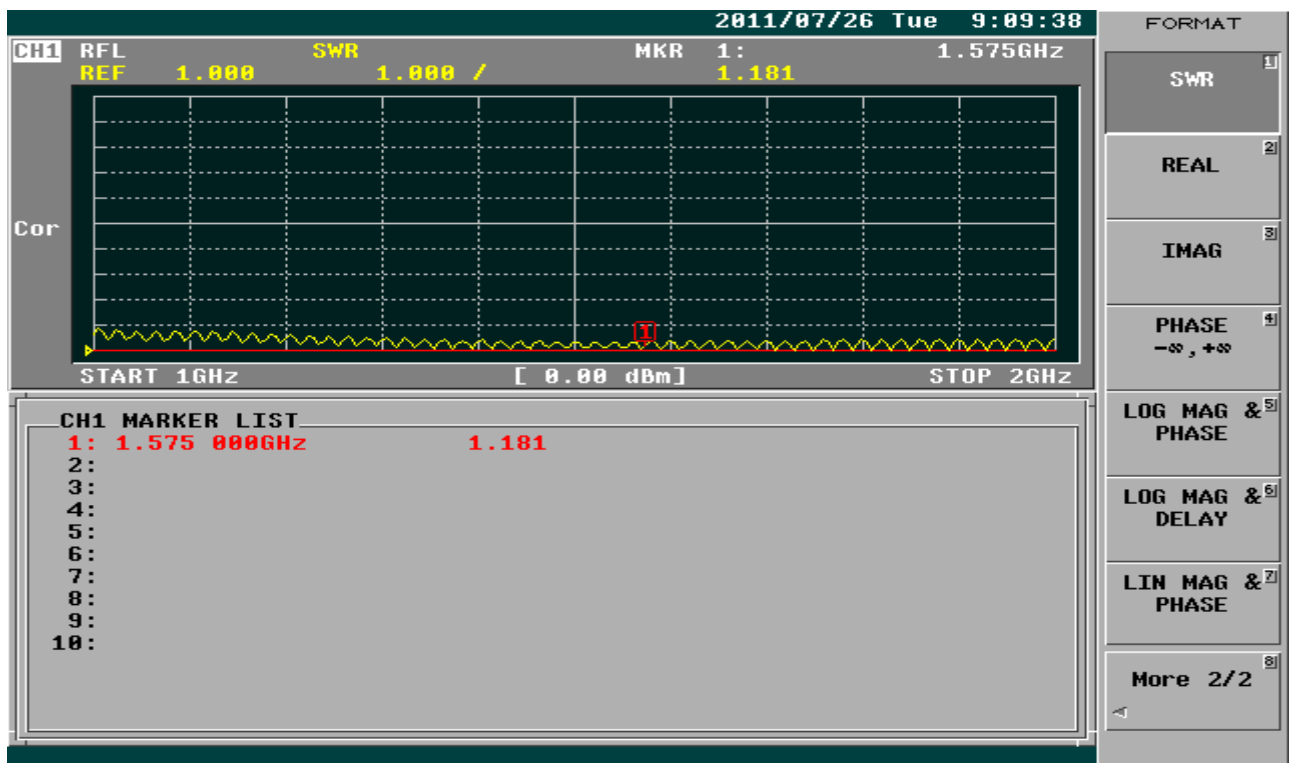

GSM TEST :

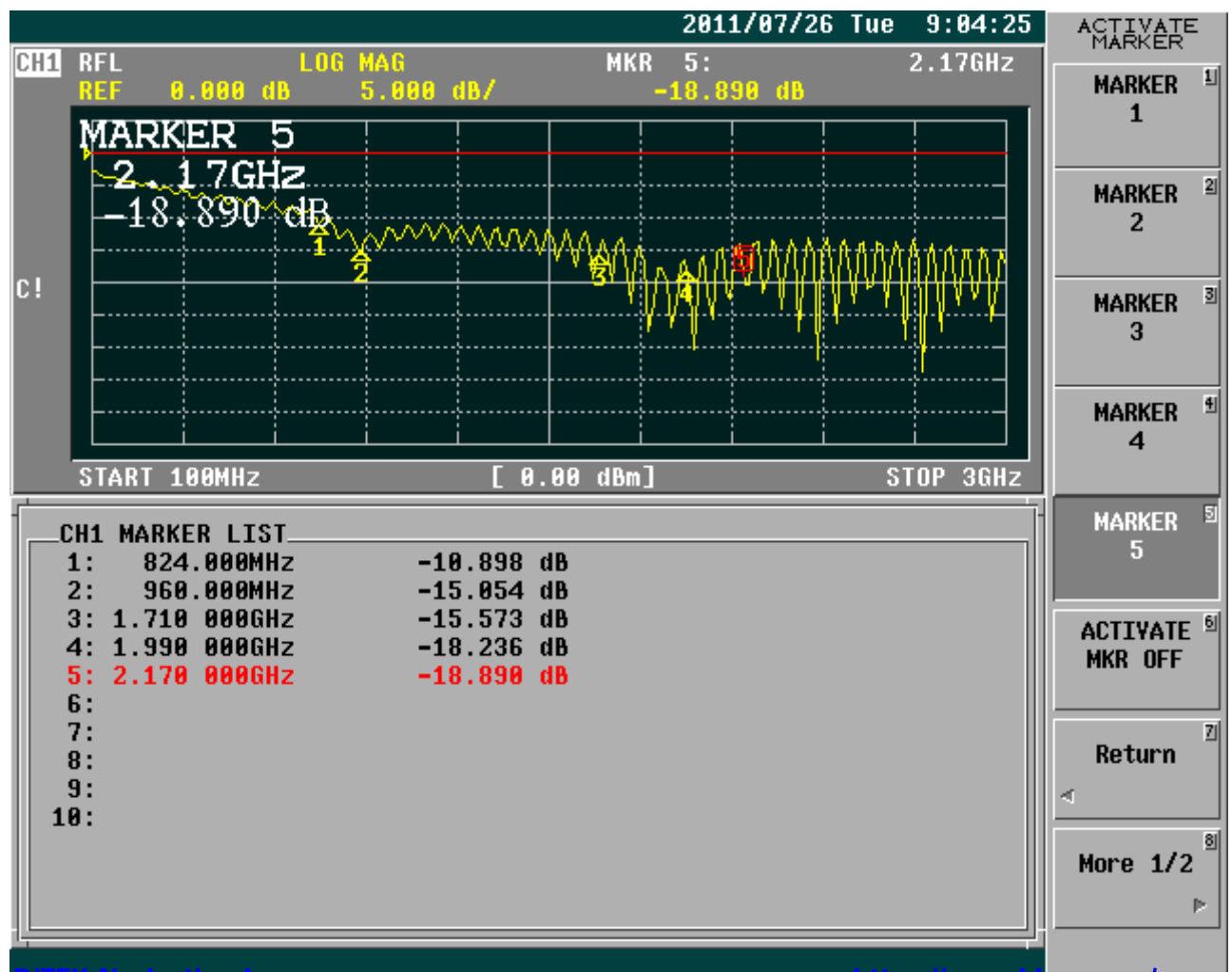
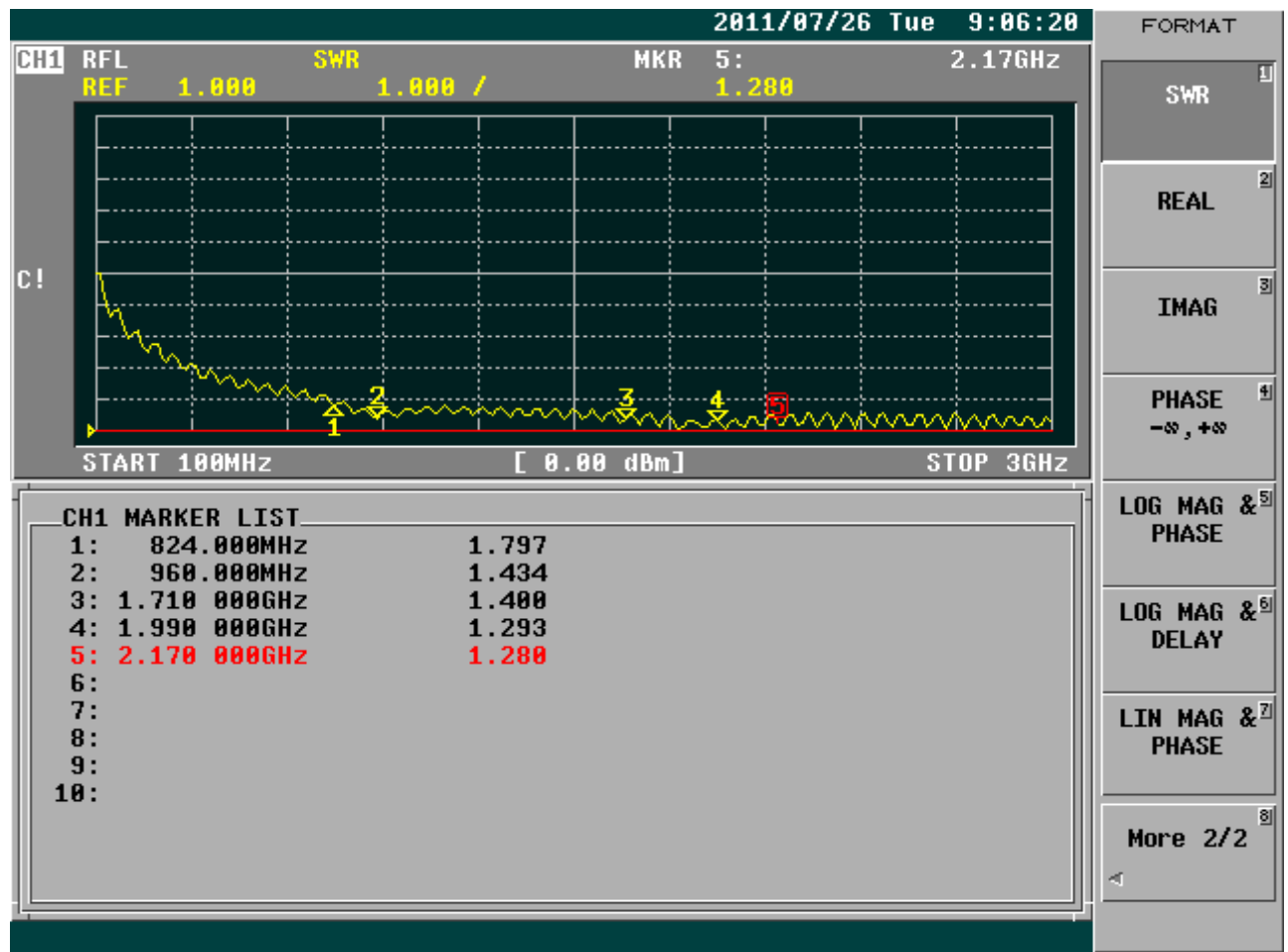

FM TEST :

