

Marine GPS Receiver & Locator

MODEL: GM65L

Small size and ruggedness, demand of vehicle locating and marine navigation GPS Receiver that will sustain harsh environment.



GM65L is a Mini Marine GPS receiver build-in well-known SiRF StarIII GPS chipset. GM65L provides customer high position, velocity and time accuracy performances as well as high sensitivity and tracking capabilities. Customers benefit from the strength of both companies. Thanks to the low power consumption technology, the GPS-Mouse receiver is ideal for many portable applications such as PDA, Tablet PC, smart phone etc.

Features

Built-in high performance SiRF Star III low power chipset.

Current consumption 40mA

20 channels parallel.

Average Cold Start in 42 seconds.

-159 dBm sensitivity in tracking mode

NMEA0183 compliant protocol

Extreme fast TTFF at low signal level

Water proof IP67

Applications

Automotive

Personal/Portable Navigation (PDA)

Geographic Surveying

Sports and Recreation

Marine Navigation

Fleet Management

AVL and Location-Based Services

GPS Features		Datum	
Chipset	SiRF Star III LP chipset	WGS-84	
Frequency	L1, 1575.42MHz		
C/A Code	1.023MHz chip rate	Dynamic Conditions	
Channels	20 channels	Altitude	<18,000 m (60,000feet)
Antenna	Built-in 25x25x4mm patch antenna	Velocity	<515 m/s (1000 knots)
		Acceleration	<4G
Sensitivity		Motional Jerk	20m/sec ³ max.
To - 159dBm Tracking, Superior Urban Canyon Performance			
		Interface	
		GPS Protocol: NMEA-0183 - GGA, GSA, GSV, RMC, VTG(Default)	
Time to First Fix (TTFF)		RS232 or TTL Output	
Cold Start	42 sec, average	Data bit: 8, stop bit: 1 (Default)	
Warm Start	38 sec, average	Baud Rate : 4800 (Default)	
Hot Start	6 sec, average	Device Size and Weight	
Reacquisition	0.1 sec	60mm(Dia.) x 45mm(H) 65grams (w/o cable & connector).	
Update rate : 1 Hz (std.)		Bulkhead mount with 0.8 inch threaded wing nut (standard accessory). FB6 2.5mm SUS L-Mounting	
Accuracy		Environmental Characteristics	
Position	5m CEP without SA, 10m 2D, RMS	Operating Temperature	- 30°C to + 85°C
Velocity	0.1m/sec, without SA		
Time	1µs synchronized to GPS time	Storage Temperature	- 40°C to + 95°C
Cable(standard)	0.5M-PS2(M)		
Optional cable	5M & 10M & 15M PS2(M) to PS2(F)	Power : Operation Current 55mA (Average) Power Input 5V ±5% VDC	
Optional : RS232 Interface cable & Power cable		1M DB9 & 1M 12~40V Input to 5V 1M OPEN & 1M 12~40V Input to 5V	
Optional : Bluetooth interface cable		12V-26V Input & Bluetooth output	
Optional : USB interface cable		PS2(F) to USB	
Optional mounting	FB6 SUS	Water Proof	IP67

All specifications are subject to change without notice

Madel : FB-6



Size :

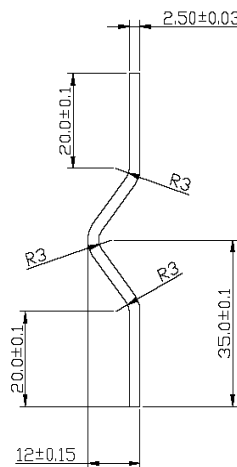
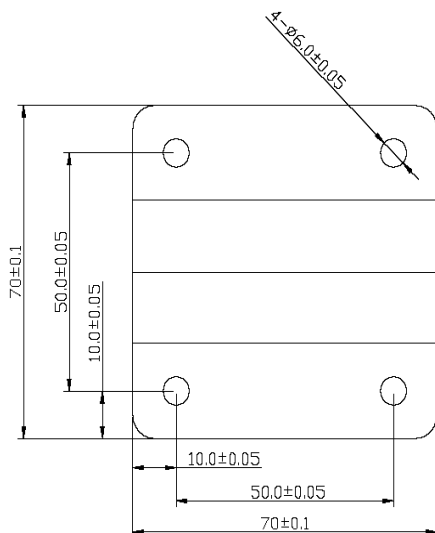
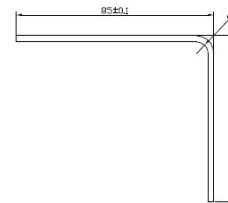
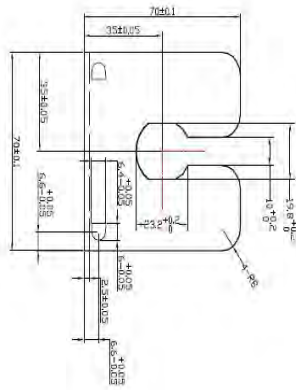
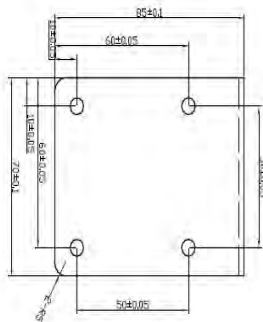

Standard :



Optional Cable :

5M



10M



15M



Pin Assignment of standard PS2 male Din Jack

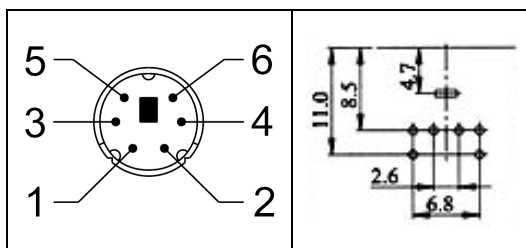

Pin	Signal
1	GND
2	+5V
3	N.C.(RS-232_Rx on demand)
4	TTL_RX
5	N.C.(RS-232_Tx on demand)
6	TTL_TX

Optional RS232 Interface cable & Power cable :

GM65A



GM65B



GM65C



Pin Assignment of D-SUB 9 PIN Female connector

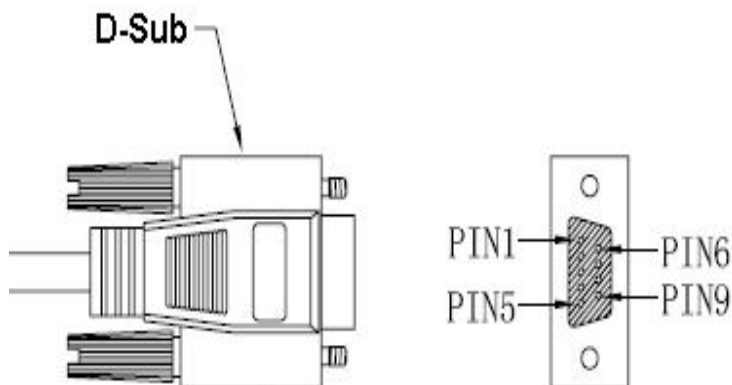

GM62A			GM62B		GM62C
DB9(F) – RS232 & Power cable			OPEN – RS232 & Power cable		DB9
PIN1	N.C	VCC 12~40V to 5V	Red	Vcc	VCC 5V
PIN2	RS232-TX		Green	RS232-TX	RS232-TX
PIN3	RS232-RX		White or Blue	RS232-RX	RS232-RX
PIN4	N.C.		Yellow	TTL - TX	N.C.
PIN5	GND	GDN	Orange	TTL - RX	GND
PIN6	N.C.		Black	GND	N.C.
PIN7	N.C.		Shielded wire	GND	N.C.
PIN8	N.C.				N.C.
PIN9	N.C.				N.C.

Table 3 NMEA-0183 V2.3 Output Messages

NMEA Sentence	Description
GGA (default)	Global Positioning System Fixed Data
GLL (default)	Geographic Position - Latitude/Longitude
GSA (default)	GNSS DOP and Active Satellites
GSV (default)	GNSS Satellites in View
RMC (default)	Recommended Minimum Specific GNSS data
VTG (default)	Course Over Ground and Ground Speed
ZDA (default)	Time and Date

GGA--- Global Positioning System Fixed Data

Table 4 contains the values for the following example:

\$GPGGA,092725.00,4717.11399,N,00833.91590,E,1,8,1.01,499.6,M,48.0,M,,0*5B

Table 4 GGA Data Format

Name	Example	Units	Description
Message ID	\$GPGGA		GGA protocol header
UTC Time	092725.00		hhmmss.ss, Current time
Latitude	4717.11399		ddmm.mmmmm, Degrees + minutes
N/S Indicator	N		N=north or S=south
Longitude	00833.91590		dddmm.mmmmm, Degrees + minutes
E/W Indicator	E		E=east or W=west
Position Fix Indicator	1		See Table 5
Satellites Used	8		Range 0 to 12
HDOP	1.01		Horizontal Dilution of Precision
MSL Altitude	499.6	m	
Units	M	meters	Meters (fixed field)
Geoid Separation	48.0	m	
Units	M	meters	Meters (fixed field)
Age of Differential Corrections		second	Blank (Null) fields when DGPS is not used
Diff. Ref. Station ID	0		
Checksum	*5B		
<CR> <LF>			End of message termination

Table 5 Position Fix Indicator

Value	Description
0	No fix or invalid

Standard GPS (2D/3D)	
2	Differential GPS
6	Estimated (DR) Fix

GLL--- Geographic Position – Latitude/Longitude

Table 6 contains the values for the following example:

\$GPGLL,4717.11364,N,00833.91565,E,092321.00,A,A*60

Table 6 GLL Data Format

Name	Example	Units	Description
Message ID	\$GPGLL		GLL protocol header
Latitude	4717.11364		ddmm.mmmmm, Degrees + minutes
N/S Indicator	N		N=north or S=south
Longitude	00833.91565		dddmm.mmmmm, Degrees + minutes
E/W Indicator	E		E=east or W=west
UTC Time	092321.00		hhmmss.ss, Current time
Status	A		V = Data Invalid / Receiver Warning, A=Data Valid
Status	A		N=No Fix, A=Autonomous GNSS Fix, D=Differential GNSS Fix, E=Estimated/Dead Reckoning Fix
Checksum	*60		
<CR> <LF>			End of message termination

GSA---GNSS DOP and Active Satellites

Table 7 contains the values for the following example:

\$GPGSA,A,3,23,29,07,08,09,18,26,28,,,,,1.94,1.18,1.54*0D

Table 7 GSA Data Format

Name	Example	Units	Description
Message ID	\$GPGSA		GSA protocol header
Mode 1 (Smode)	A		See Table 8
Mode 2 (Fix Status)	3		See Table 9
Satellite Used	23		SV on Channel 1
Satellite Used	29		SV on Channel 2
			Repeated for each channel
Satellite Used			Sv on Channel 12
PDOP	1.94		Position Dilution of Precision (00.0 to 99.99)
HDOP	1.18		Horizontal Dilution of Precision (00.0 to 99.99)

VDOP	1.54		Vertical Dilution of Precision (00.00 to 99.99)
Checksum	*0D		
<CR> <LF>			End of message termination

Table 8 Mode 1 (Smode)

Value	Description
M	Manual- forced to operate in 2D or 3D mode
A	Automatic-allowed to automatically switch 2D/3D

Table 9 Mode 2 (Fix Status)

Value	Description
1	Fix not available
2	2D Fix
3	3D Fix

GSV---GNSS Satellites in View

Table 10 contains the values for the following example:

```
$GPGSV,3,1,10,23,38,230,44,29,71,156,47,07,29,116,41,08,09,081,36*7F
```

```
$GPGSV,3,2,10,10,07,189,,05,05,220,,09,34,274,42,18,25,309,44*72
```

```
$GPGSV,3,3,10,26,82,187,47,28,43,056,46*77
```

Table 10 GSV Data Format

Name	Example	Units	Description
Message ID	\$GPGSV		GSV protocol header
Number of Messages	3		Total number of GPGSV messages being output , Range 1 to 3
Message Number	1		Number of this message, Range 1 to 3
Satellites in View	10		
Satellite ID	23		SV ID (GPS: 1-32, SBAS 33-64 (33=PRN120))
Elevation	38	degree	Maximum 90
Azimuth	230	degree	Range 0 to 359
SNR (C/No)	44	dBHz	Range 0 to 99, null when not tracking
			Data of 2nd, 3rd Satellite (same as above)
Satellite ID	29		SV ID
Elevation	71	degree	Maximum 90
Azimuth	156	degree	Range 0 to 359
SNR (C/No)	47	dBHz	Range 0 to 99, null when not tracking
Checksum	*7F		
<CR> <LF>			End of message termination

RMC---Recommended Minimum Specific GNSS Data

Table 11 contains the values for the following example:

```
$GPRMC,083559.00,A,4717.11437,N,00833.91522,E,0.004,77.52,091202,,A*57
```

Table 11 RMC Data Format

Name	Example	Units	Description
Message ID	\$GPRMC		RMC protocol header
UTC Time	083559.00		hhmmss.ss, Current time
Status	A		A=data valid or V=data not valid
Latitude	4717.11437		ddmm.mmmmm, Degrees + minutes
N/S Indicator	N		N=north or S=south
Longitude	00833.91522		dddmm.mmmmm, Degrees + minutes
E/W Indicator	E		E=east or W=west
Speed	0.004	knots	Speed Over Ground
COG	77.52	degree	Course Over Ground (true)
Date	091202		Ddmyy, Current Date in Day, Month Year format
Magnetic Variation		degrees	E=east or W=west (Not being output by receiver)
Magnetic variation E/W indicator			Not being output by receiver
Mode Indicator	A		N=No Fix, A=Autonomous GNSS Fix, D=Differential GNSS Fix, E=Estimated/Dead Reckoning Fix
Checksum	*53		
<CR> <LF>			End of message termination

VTG---Course Over Ground and Ground Speed

Table 12 contains the values for the following example:

```
$GPVTG,77.52,T,,M,0.004,N,0.008,K,A*06
```

Table 12 VTG Data Format

Name	Example	Units	Description
Message ID	\$GPVTG		VTG protocol header
COG	77.52	degrees	Course Over Ground (true)
	T		True
COG		degrees	Course Over Ground (maganetic) (Not being output by receiver)
	M		Magnetic
Speed	0.004	knots	Speed over ground
Units			Knots

Speed	0.008	km/hr	Speed over ground
Units	K		Kilometer per hour
Mode	A		N=No Fix, A=Autonomous GNSS Fix, D=Differential GNSS Fix, E=Estimated/Dead Reckoning Fix
Checksum	*0B		
<CR> <LF>			End of message termination

ZDA---Time and Date

Table 13 contains the values for the following example:

\$GPZDA,082710.00,16,09,2002,00,00*64

Table 13 ZDA Data Format

Name	Example	Units	Description
Message ID	\$GPZDA		ZDA protocol header
UTC Time	081727.00	degrees	hhmmss.ss
Day	16		01 to 31
Month	09		01 to 12
Year	2002		4 digit year
Local zone hours	00		(Not being output by receiver) (fixed to 00)
Local zone minutes	00		(Not being output by receiver) (fixed to 00)
Checksum	*64		
<CR> <LF>			End of message termination