

RFID INTERNAL ANTENNA

MODEL: IA-868A

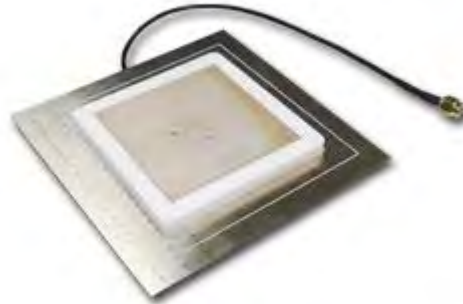

SPECIFICATION

1.	WORKING FREQUENCY	865~868Mhz or 902~928Mhz
2.	Patch Antenna	Dielectric Ceramics
3.	IMPEDANCE	50 Ohm
4.	V.S.W.R	1.5
5.	GAIN	5dBi
6.	Cable & Connector	RG174-200mm-SMA(M)
7.	POLARIZATION	RHCP
8.	POWER HANDLING	2 W
9.	OPERATING TEMPERATURE	-40°C -- +85°C
10.	Antenna Dimensions	120 mm x 120 mm x 6.5mm

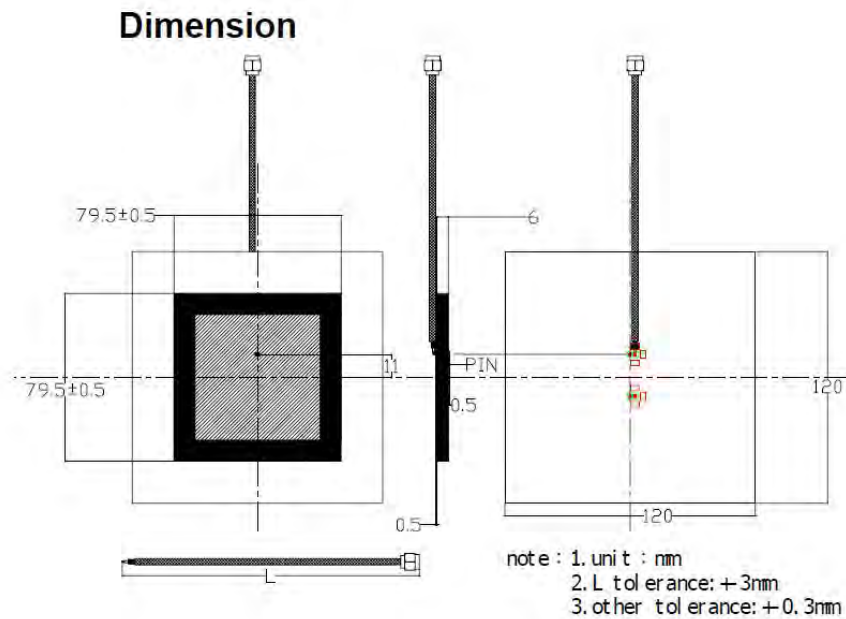

Electrical Characteristics

特 性	型 號	IA-868-200mm-SMA(M)
頻率範圍 Frequency Range		855~880 Mhz
中心頻率 Center Frequency		868 +/-2Mhz
電壓駐波比 V.S.W.R		1.5:1
帶 寬 Band Width		>26MHz
阻 抗 Impedence		50 Ω
最高增益 Peak Gain		5.0dBic , Based on 12×12cm ground plane without cable
天線極化 Polarization		RHCP

Testing Conditions

工作溫度 Operation Temp	-20℃~+65℃
儲存溫度 Storage Temp	-40℃~+85℃
振動 Vibration	Sine sweep 1g(0-p) 10~50~10Hz each axis

Sample Test

I. SUMMARY :

This report to account for the measurement setup and result of the Antenna.

1. The measurement setup includes s-parameter, pattern, and gain measurement.
2. The measured data for Antenna are presented and analysis.

II. S-PARAMETER MEASUREMENT :

1. Reflection coefficient :

(a) Instrument : Network Analyzer.

(b) Setup :

- (1) Calibrate the Network Analyzer by one port calibration using O.S.L. calibration kits.
- (2) Connect the antenna under test to the Network Analyzer.
- (3) Measure the S11(reflection coefficient) shown in Fig. 1.
- (4) Generally, the S11 is less than -10dB to ensure the 90% power into antenna and only less than 10% power back to system.

NETWORK ANALYZER

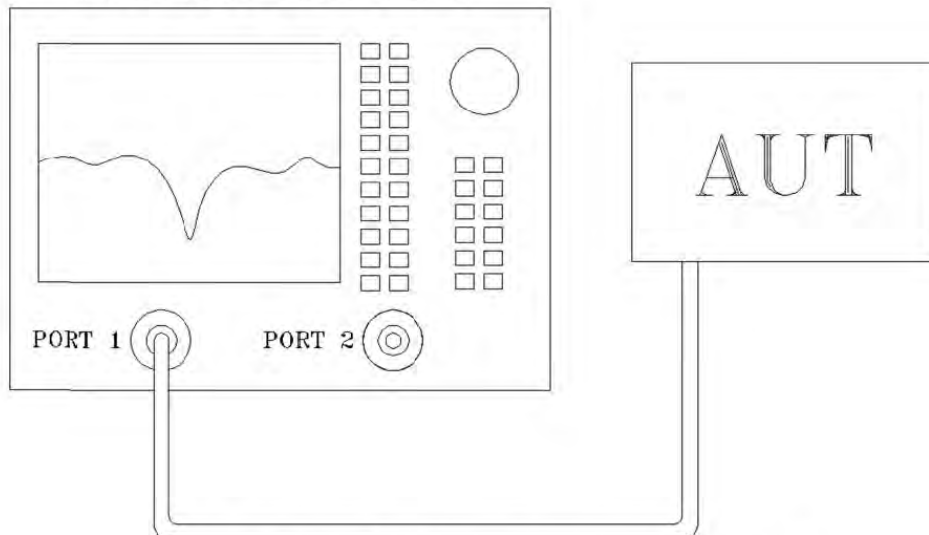
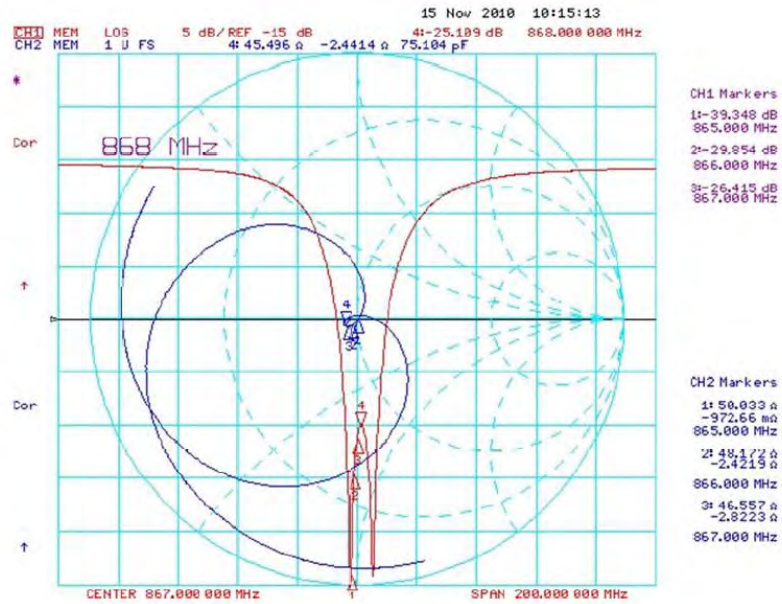
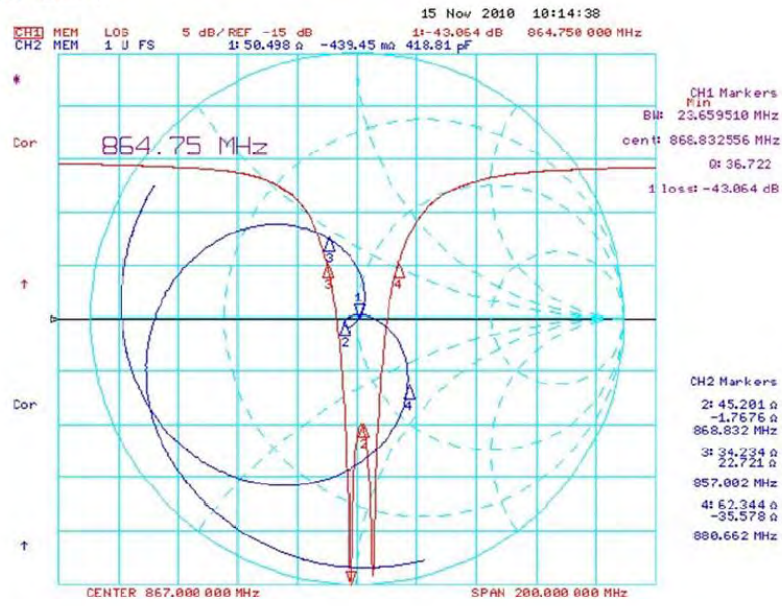
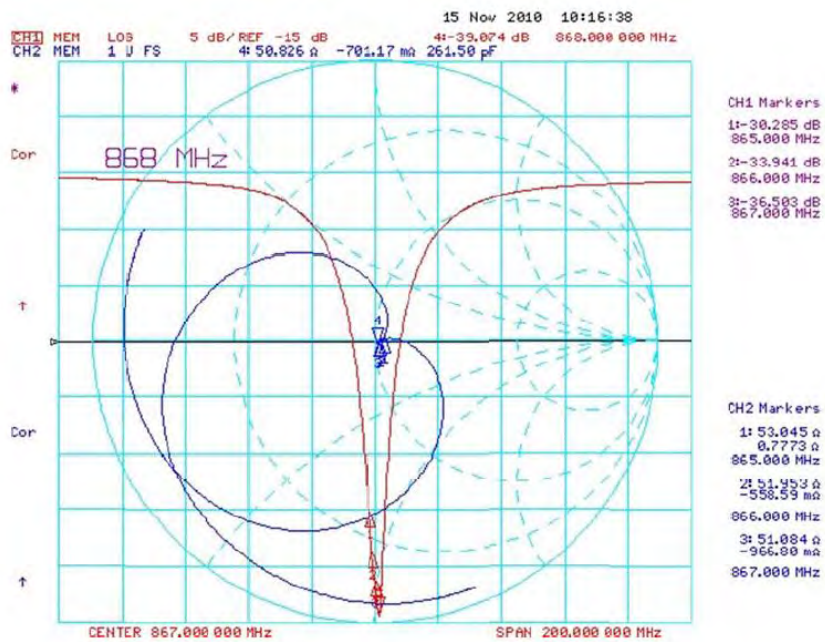
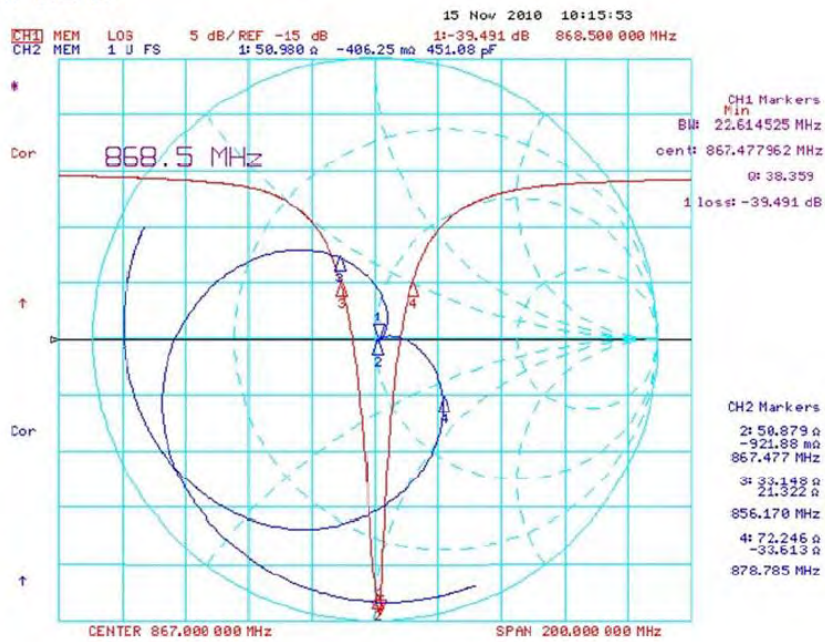

Fig.1 Antenna measured in Network Analyzer

S-PARAMETER TEST RESULT :
1. SAMPLE-1



SAMPLE-2



SAMPLE-3

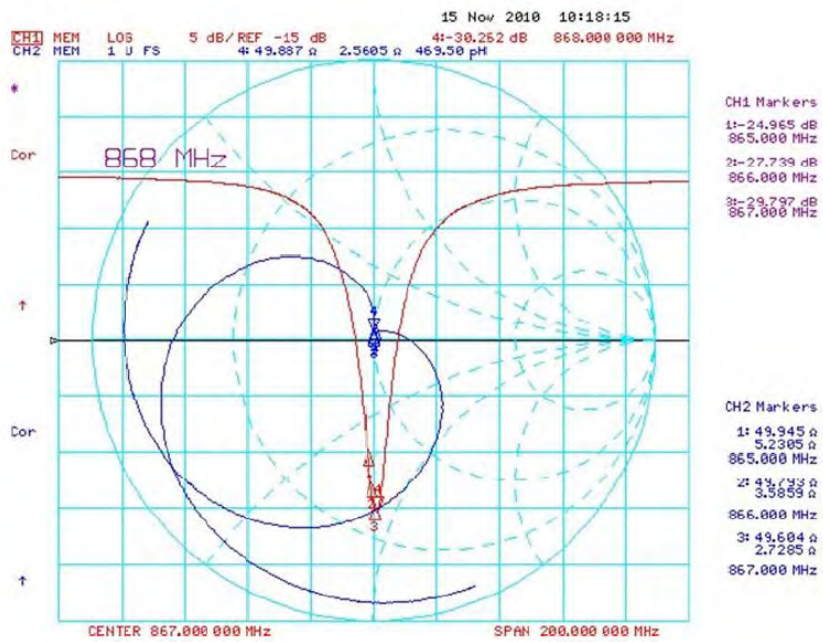
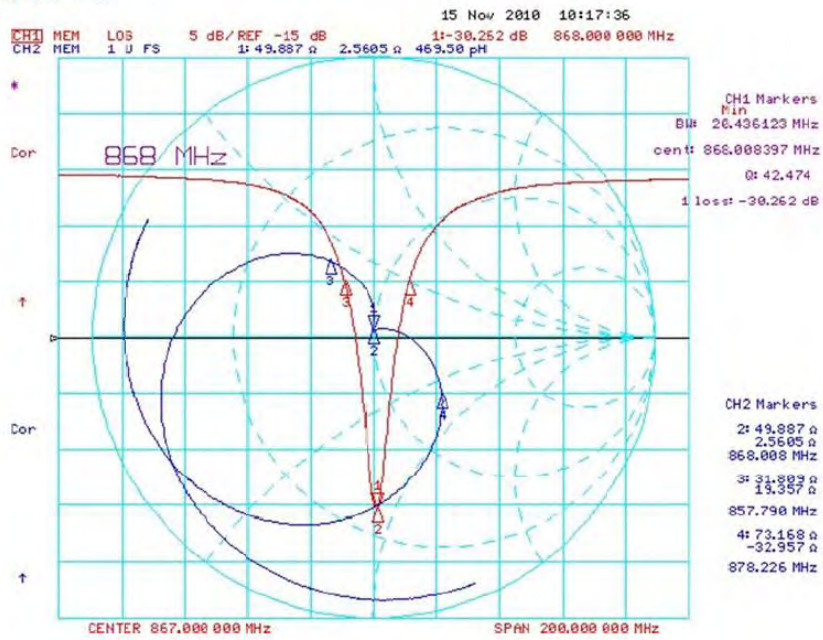

SAMPLE-4

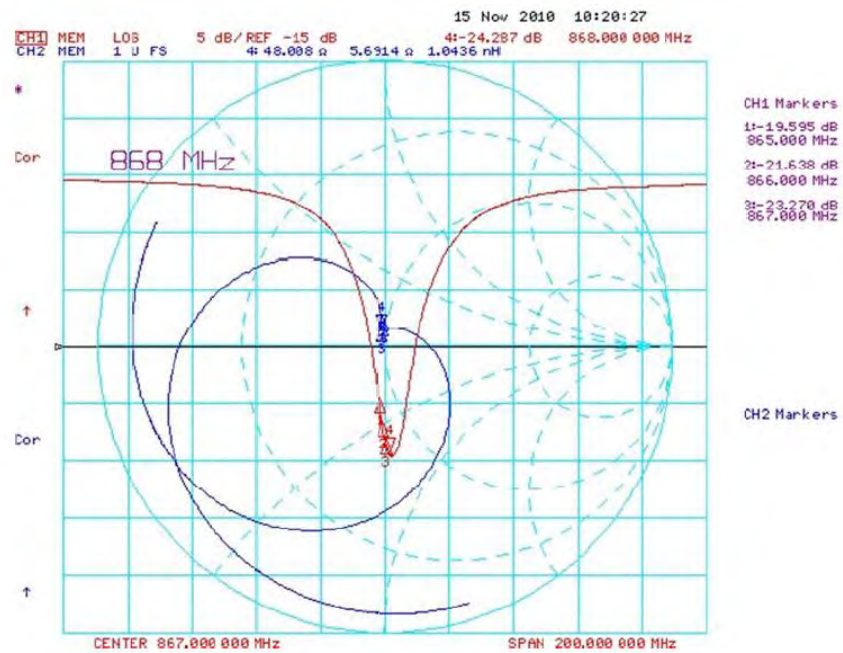
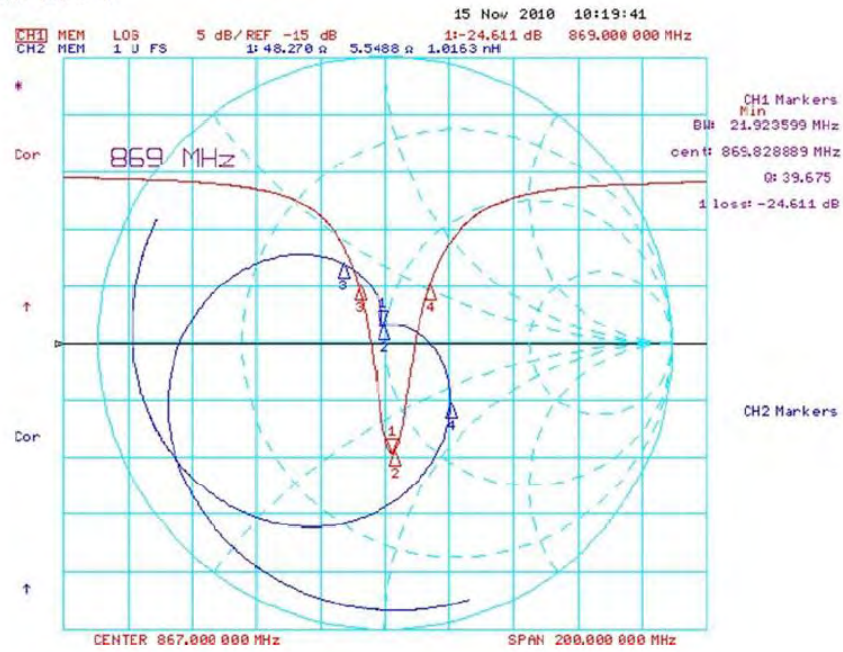

III. THE TEST INFORMATION IN ANECHOIC CHAMBER

1. Measurement System:

(a) Instruments: anechoic antenna, network analyzer, standard gain horns antenna.

(b) Anechoic chamber description:

(1) The anechoic chamber is a far-field measurement system with size of 3.25M*2.84M*6.4M. The quiet zone of this chamber shall be greater than 70cm @ 0.9GHz, 50cm @ 1.8GHz, 44cm @ 2.4GHz, 28cm @ 5.8GHz, 16cm @ 18GHz.

(2) Fig.2 shows the interior components of the anechoic chamber.

The antenna standard antenna as probe and antenna under test is 3M. The antenna under test is fixed on two step rotators. We control the rotating angle for accurate or rough measurement.

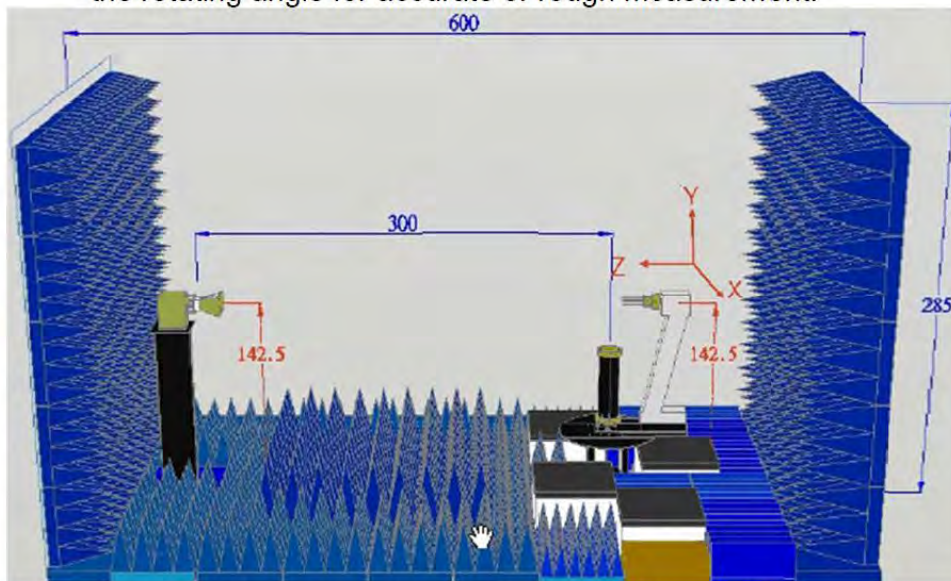

Fig.2 The interior components of the anechoic

(3) While we measure the radiation patterns by rotating AUT with 360 degrees phi axis along 180 degrees theta axis and repeat again by replacing the AUT with the standard gain antenna under test, we compare both data and using a formula to obtain the

$$G_{AUT} = G_{STAND} + P_{AUT} - P_{STAND}$$

G_{AUT} : Gain of AUT

G_{STAND} : Gain of Standard Gain Antenna

P_{AUT} : Measured Power of AUT

P_{STAND} : Measured Power of Standard Gain Antenna

(4) The axis defined in the Fig.3.

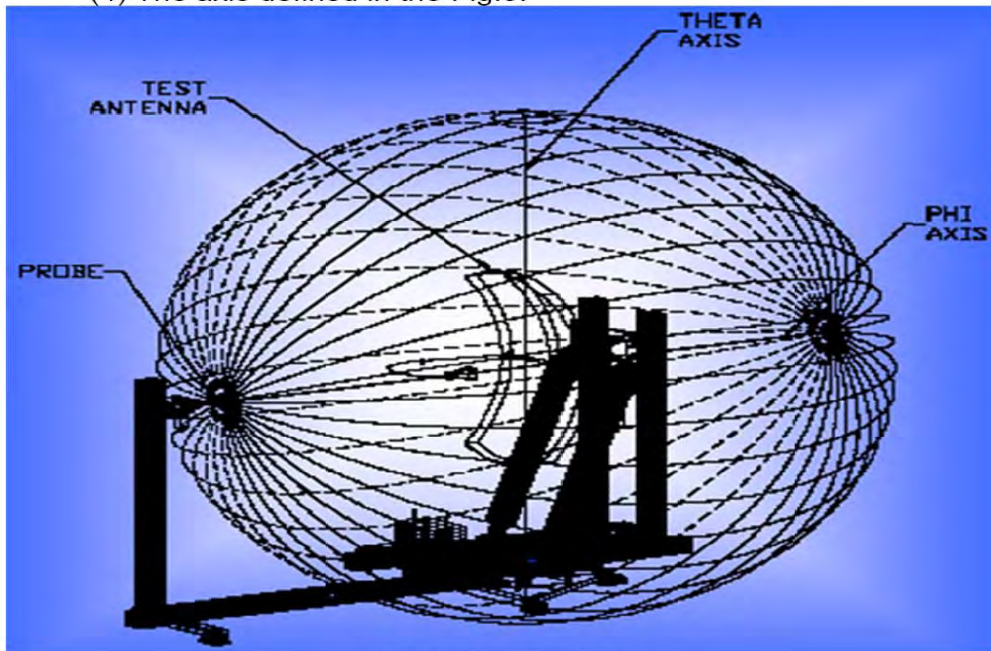
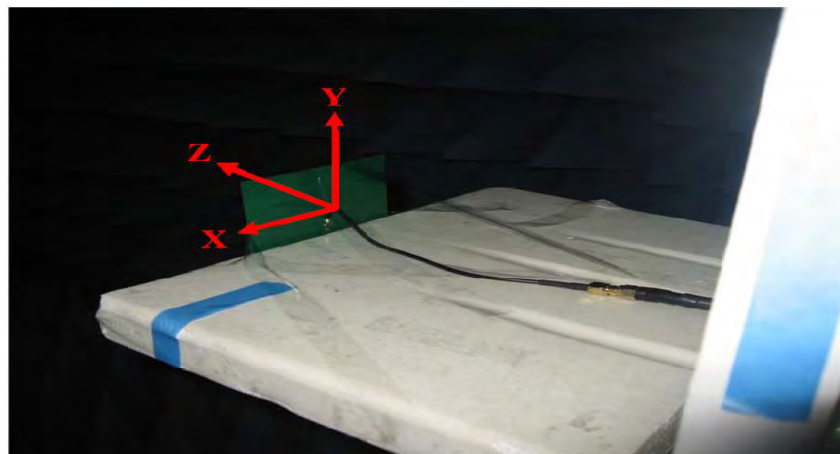
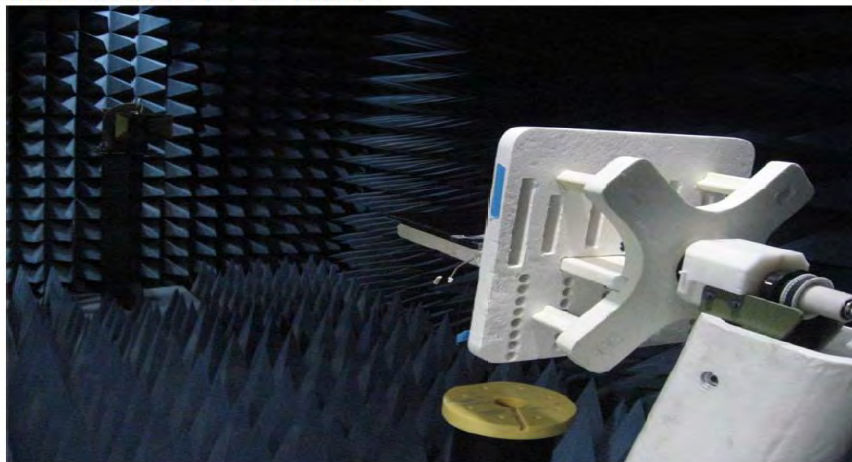

Fig.3 The axis defined

V. CHAMBER TEST PICTURE



VI. CHAMBER TEST RESULT

1. PATTERN

(a) Frequency : 865MHz

Far-field Pattern @ $\Phi=0$ deg(E-Theta Plane-Cut)
Plot Peak Gain= 4.26 dBi; Co-Pol Efficiency: 71.73% @ Freq: 0.86500 GHz

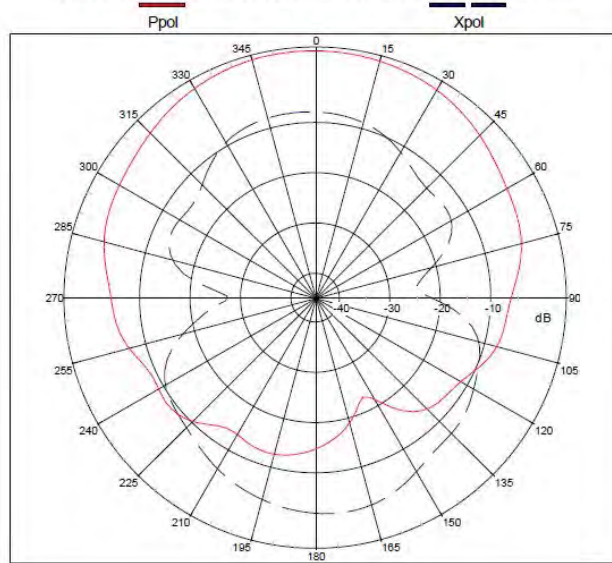

XZ-PLANE

Far-field Pattern @ $\Phi=90$ deg(E-Theta Plane-Cut)
Plot Peak Gain= 4.53 dBi; Co-Pol Efficiency: 71.73% @ Freq: 0.86500 GHz

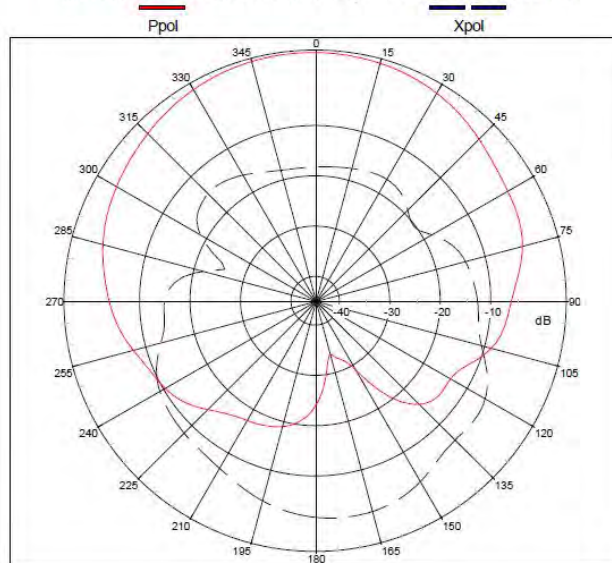

YZ-PLANE

Far-field Pattern @ Theta=90 deg(E-Phi Plane-Cut)
Plot Peak Gain= -3.43 dBi; Co-Pol Efficiency: 71.73% @ Freq: 0.86500 GHz

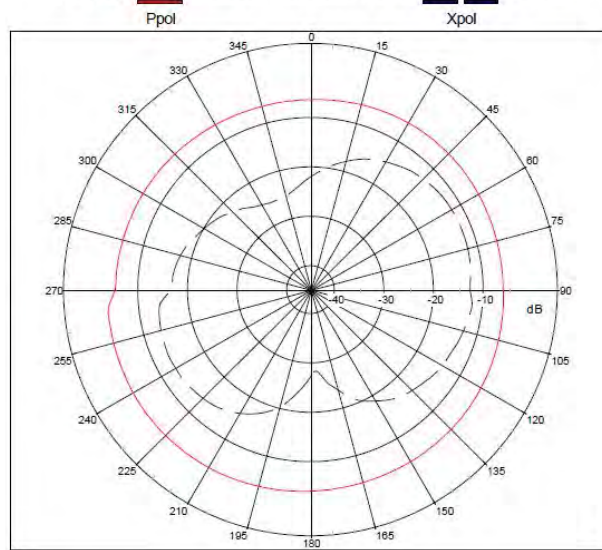

(b) Frequency : 866MHz

Far-field Pattern @ Phi=0 deg(E-Theta Plane-Cut)
Plot Peak Gain= 4.44 dBi; Co-Pol Efficiency: 73.17% @ Freq: 0.86600 GHz

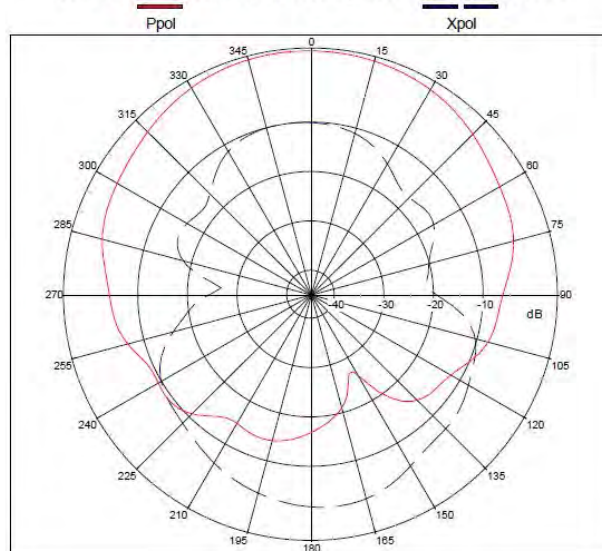

Far-field Pattern @ Phi=90 deg(E-Theta Plane-Cut)
Plot Peak Gain= 4.64 dBi; Co-Pol Efficiency: 73.17% @ Freq: 0.86600 GHz

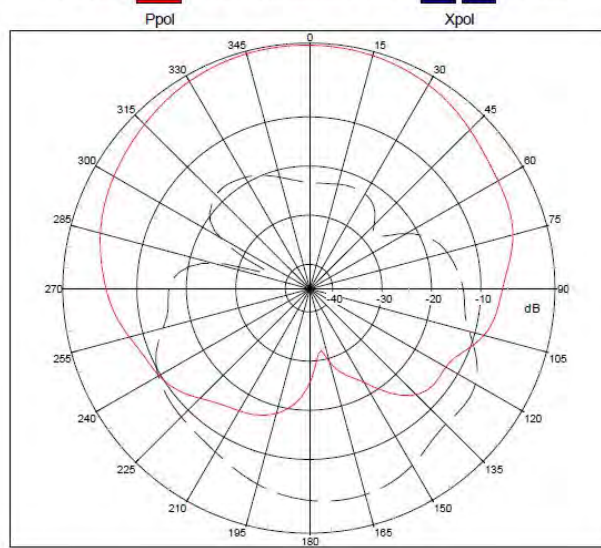

Far-field Pattern @ Theta=90 deg(E-Phi Plane-Cut)
Plot Peak Gain= -3.29 dBi; Co-Pol Efficiency: 73.17% @ Freq: 0.86600 GHz

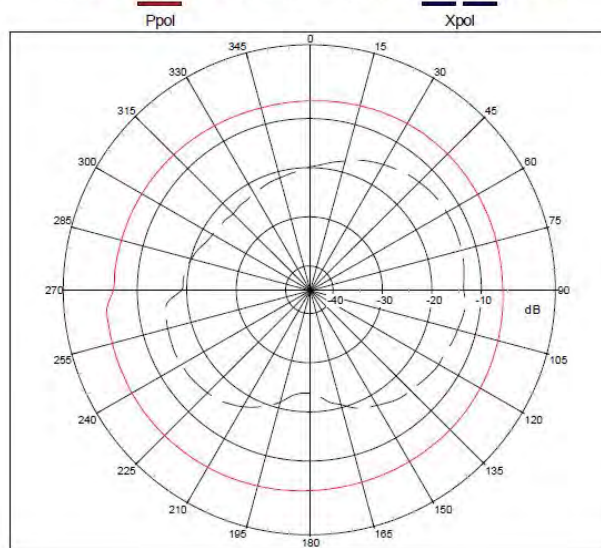

(c) Frequency : 867MHz

Far-field Pattern @ Phi=0 deg(E-Theta Plane-Cut)
Plot Peak Gain= 4.55 dBi; Co-Pol Efficiency: 73.69% @ Freq: 0.86700 GHz

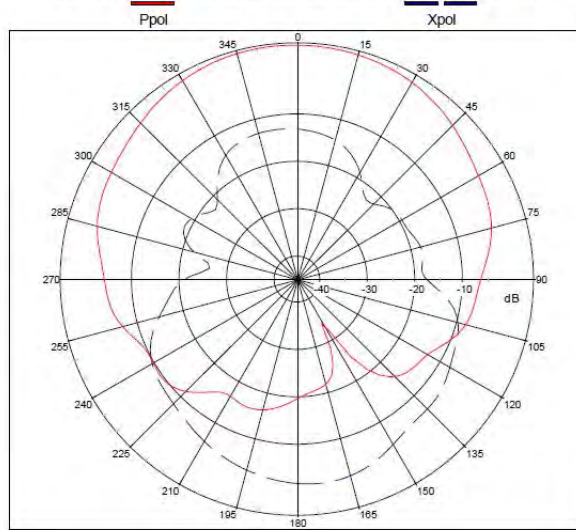

XZ-PLANE

Far-field Pattern @ Phi=90 deg(E-Theta Plane-Cut)
Plot Peak Gain= 4.65 dBi; Co-Pol Efficiency: 73.69% @ Freq: 0.86700 GHz

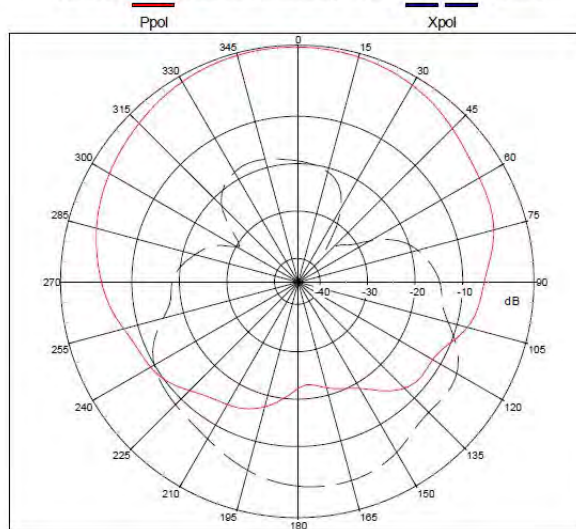

YZ-PLANE

Far-field Pattern @ Theta=90 deg(E-Phi Plane-Cut)
Plot Peak Gain= -3.23 dBi; Co-Pol Efficiency: 73.69% @ Freq: 0.86700 GHz

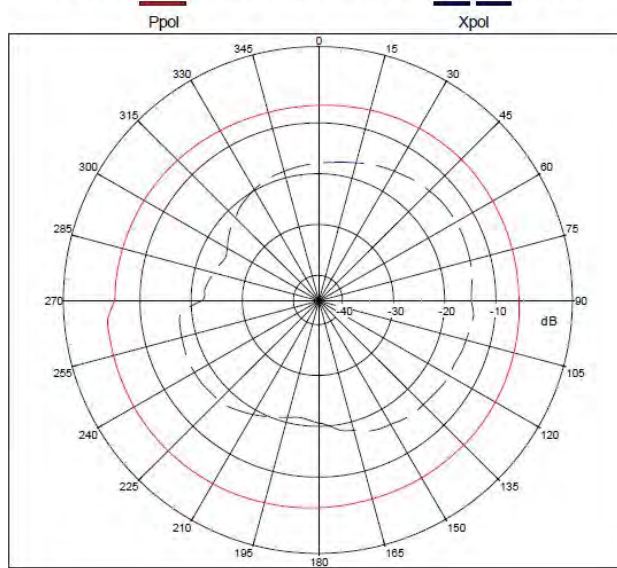

(d) Frequency : 868MHz

Far-field Pattern @ Phi=0 deg(E-Theta Plane-Cut)
Plot Peak Gain= 4.59 dBi; Co-Pol Efficiency: 73.67% @ Freq: 0.86800 GHz

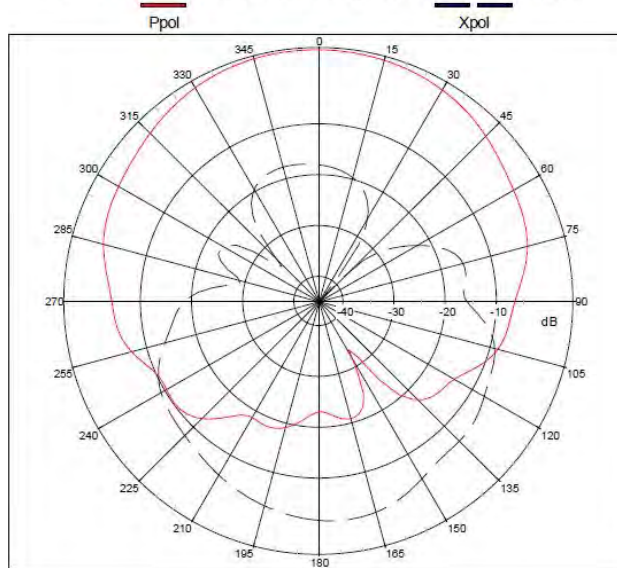

Far-field Pattern @ Phi=90 deg(E-Theta Plane-Cut)
Plot Peak Gain= 4.60 dBi; Co-Pol Efficiency: 73.67% @ Freq: 0.86800 GHz

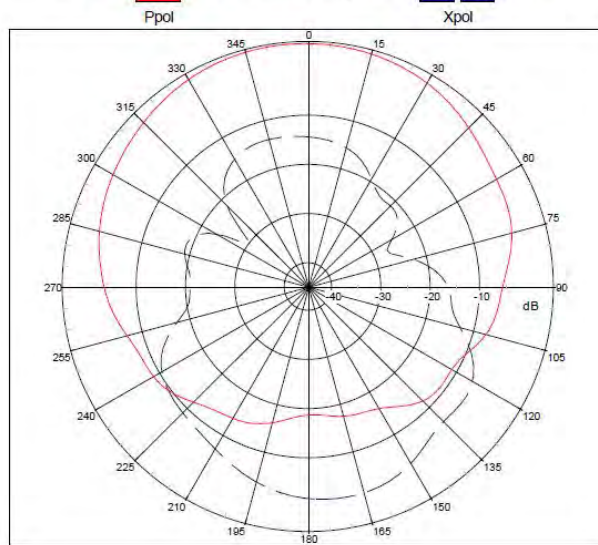

YZ-PLANE

Far-field Pattern @ Theta=90 deg(E-Phi Plane-Cut)
Plot Peak Gain= -3.24 dBi; Co-Pol Efficiency: 73.67% @ Freq: 0.86800 GHz

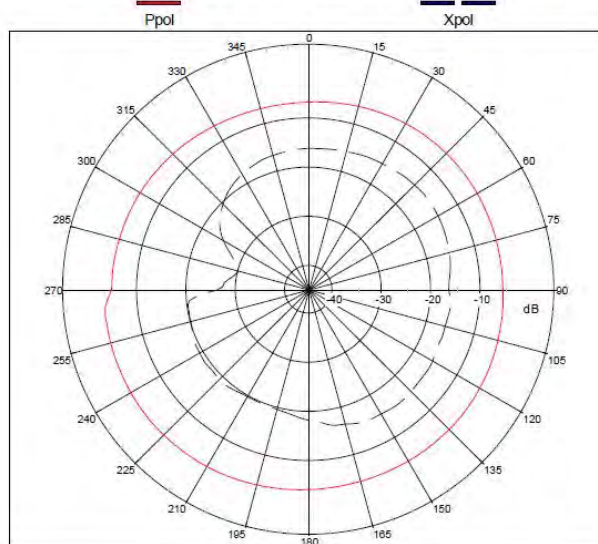

XY-PLANE

2. TEST VALUE

(a) Gain & Efficiency & Axial Ratio

Freq. (MHz)	Gain (dBic)	Gain_Power (dBic)	3D-avgGain (dBic)	Total Rad. Efficiency(%)	Axial Ratio
865	4.56	4.67	-1.44	71.73	4.37
866	4.66	4.72	-1.36	73.13	3.30
867	4.67	4.72	-1.33	73.69	2.26
868	4.63	4.69	-1.33	73.67	1.28

VII. PICTURE

