

CAR GSM Antenna

MODEL: MA-96

Five Band 800/900/1800/1900/2170MHz



1. GENERAL DESCRIPTION

Model No	P/N
MA-96	

Below is a table summarizing the antenna design specification.

1.2 Electrical Properties

Parameter	Description
Frequency Band	800/900/1800/1900/2170MHz
Nominal Impedance	50 ohm
Polarization	Vertical
Electrical Wave	1 / 2 λ Dipole
Return Loss	Please See Data-1
V.S.W.R	2.0:1
Antenna Average Gain	0~2.1dBi
Note: Gain includes the cable loss	

1.2 Mechanical Properties

Parameter	Description
Antenna Type	External Antenna
Touch Type	Screw Type
Connector Type	FME 180°-Type
Antenna Dimensions	96 mm ± 3
Antenna Cable Total Length	2500 mm ± 20
Antenna Color	Black
Operating Temperature Range	-20°C~+60°C
Storage Temperature Range	-30°C~+70°C

2. Appearance

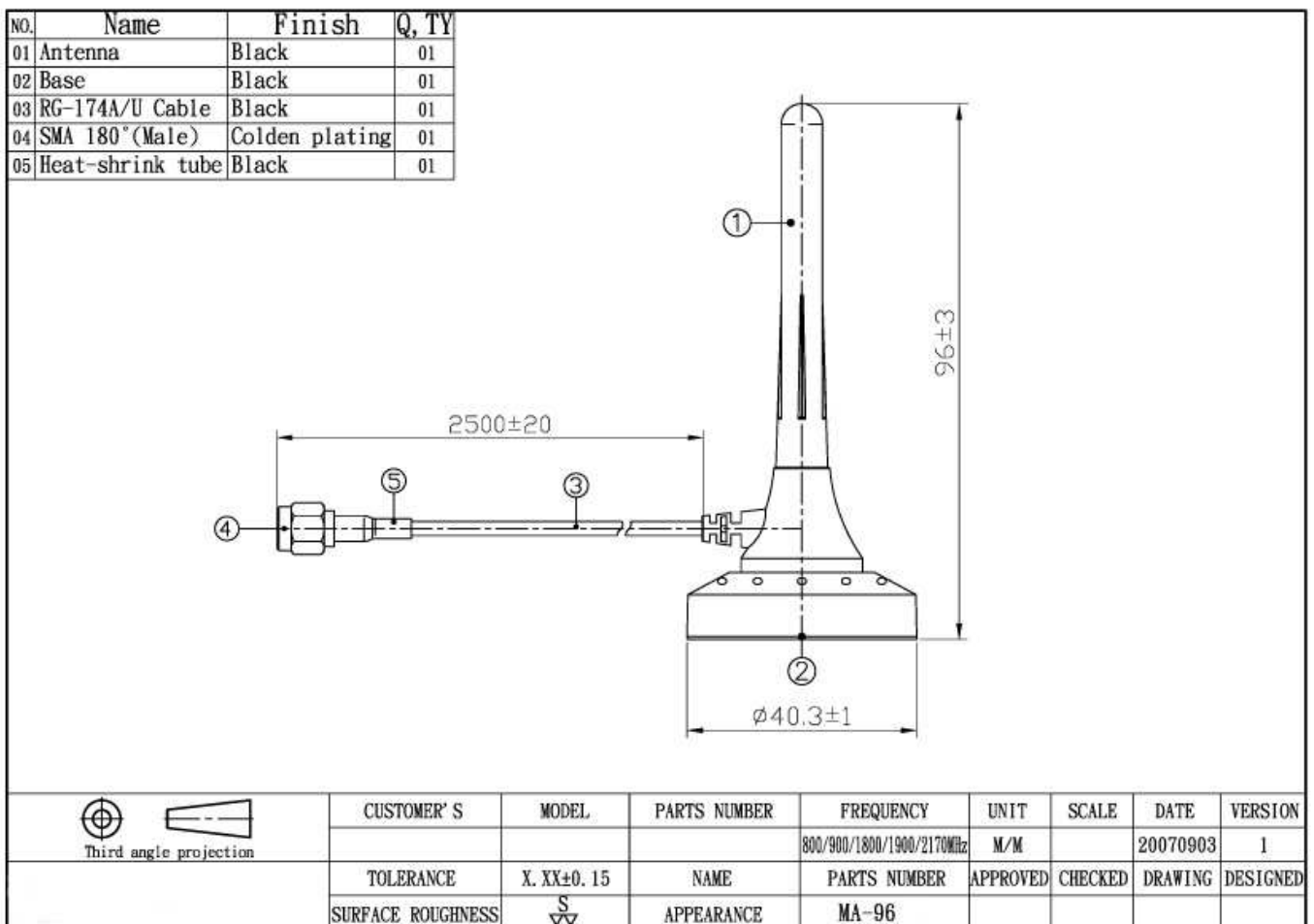

3. Frequenc

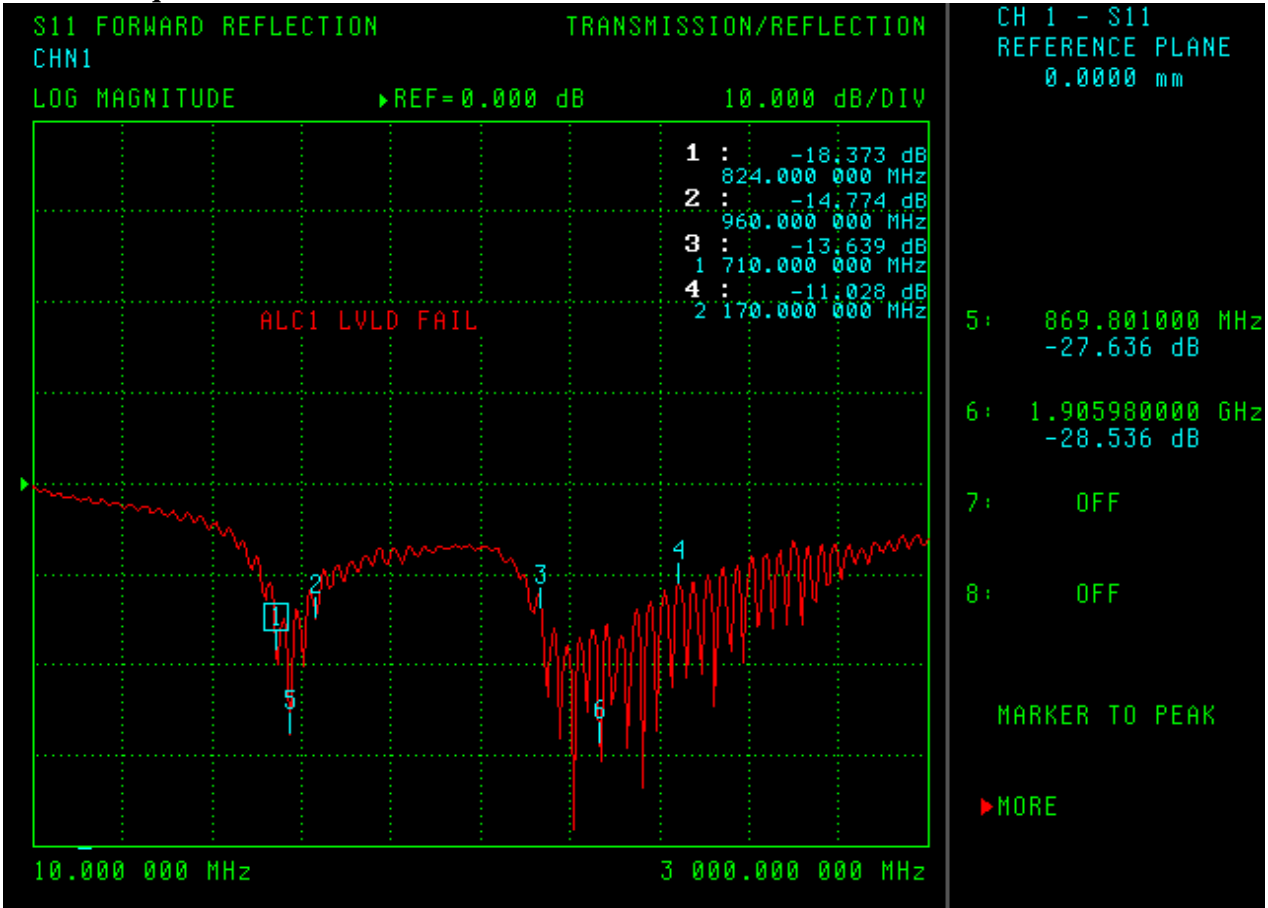

4.

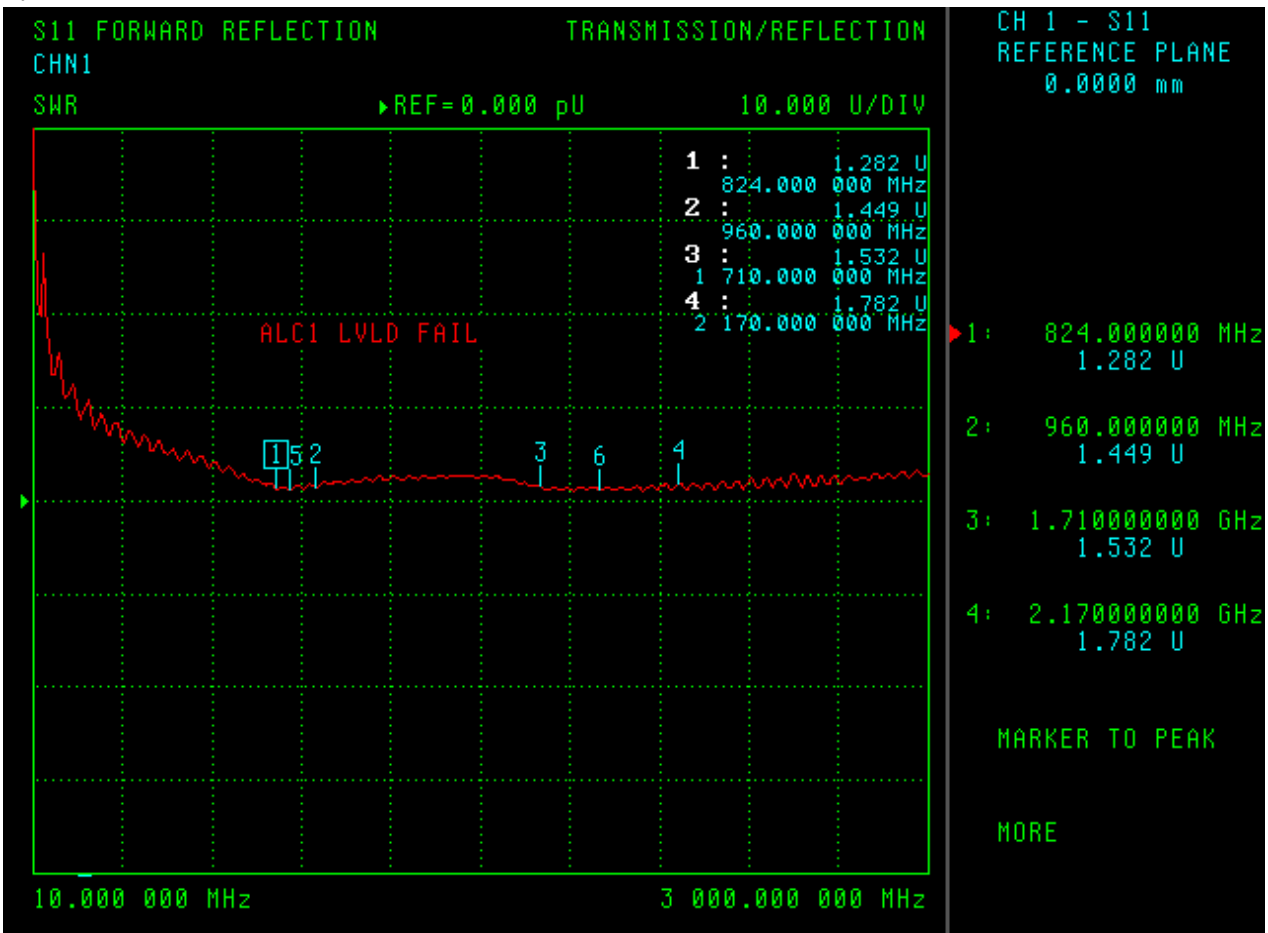

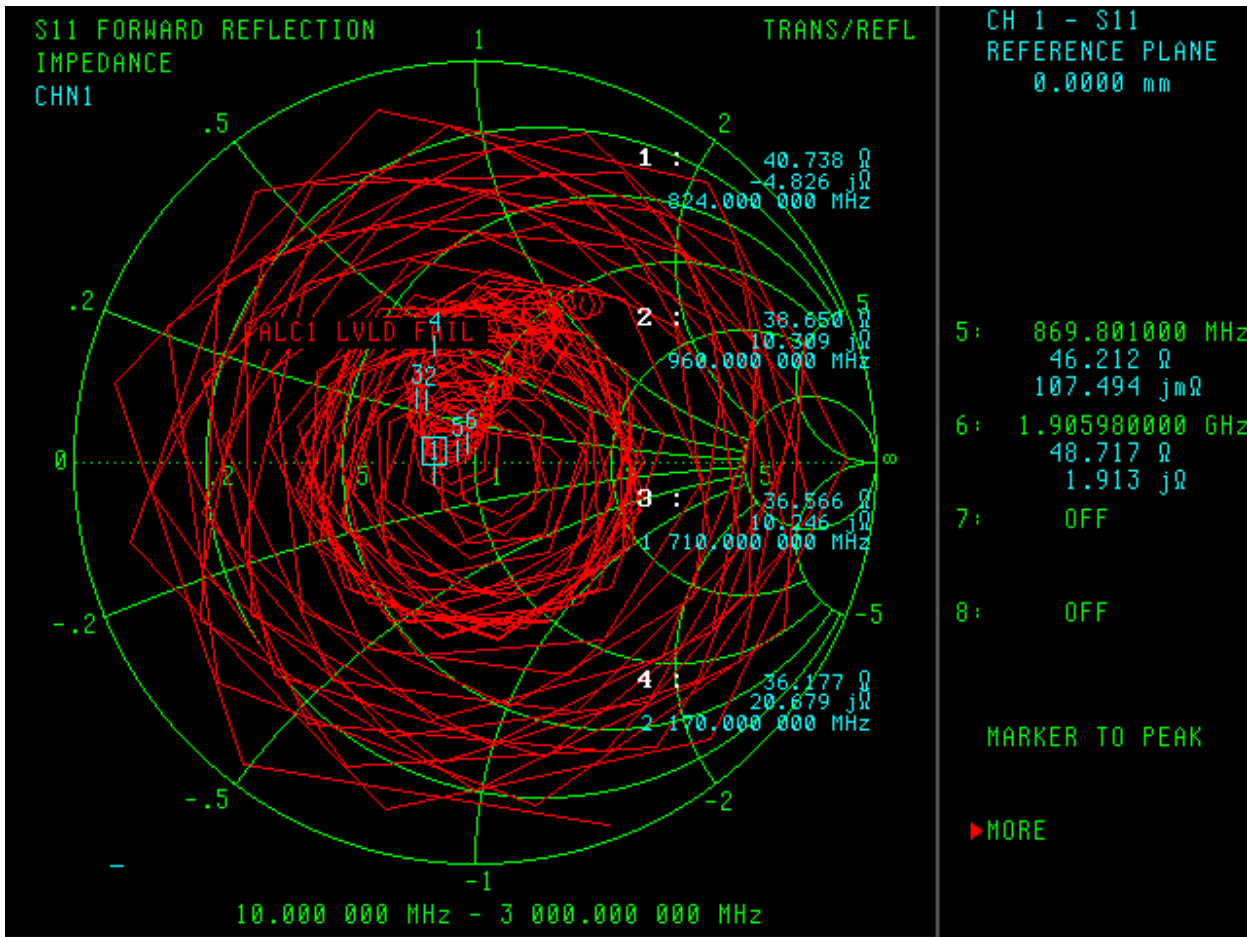

Far-field amplitude of MA-9.nsi

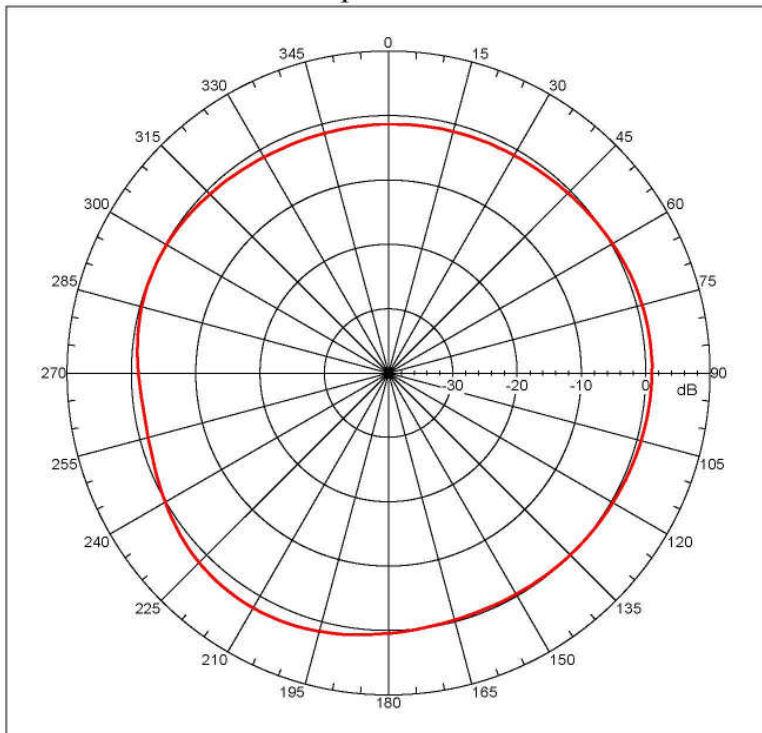

Far-field amplitude, Principal: Linear, Tau = 0.000 deg
Gain = 2.13577 dB
Max far-field (global) = -40.86357 dB, Max far-field (plot) = -40.86359 dB
Normalization: Reference, Network offset = 0.000 dB
Hpeak at: -148.00001 deg, Vpeak at: 0.000 deg
Plot centering: on

MA-5 2007/5//9H-Plane cut scan. Feeding cable at bottom side around R/C been covered by absorber to reduce possible coupling with AUT.

NSI2000 V4.0.124, Filename:C:\nsi2000\steven\MP-51 80MM\MA-9.nsi
Measurement date/time: 5/9/2007 2:53:22 PM, Filetype: NSI-97

Far-field Cut Analysis:
Avg value: -0.038 dB
-3. dB beam width: Not Found
-6. dB beam width: Not Found
-10. dB beam width: Not Found
Left Sidelobe: Not Found
Right Sidelobe: -2.27 dB at -69.385 deg

Far-field display setup
Azimuth (deg)
Span = 360.00001 deg, Center = 0.000 deg, #pts = 181
Start = -180.00001 deg, Stop = 180.00001 deg, Delta = 2.000 deg
Elevation (deg)
Center = 0.000 deg, #pts = 1

Selected beam(s) 1 of 6

Beam	Frequency	Azimuth	Elevation	Pol
1	0.824 GHz	Azimuth	Elevation	Single-pol

Far-field amplitude of MA-9.nsi

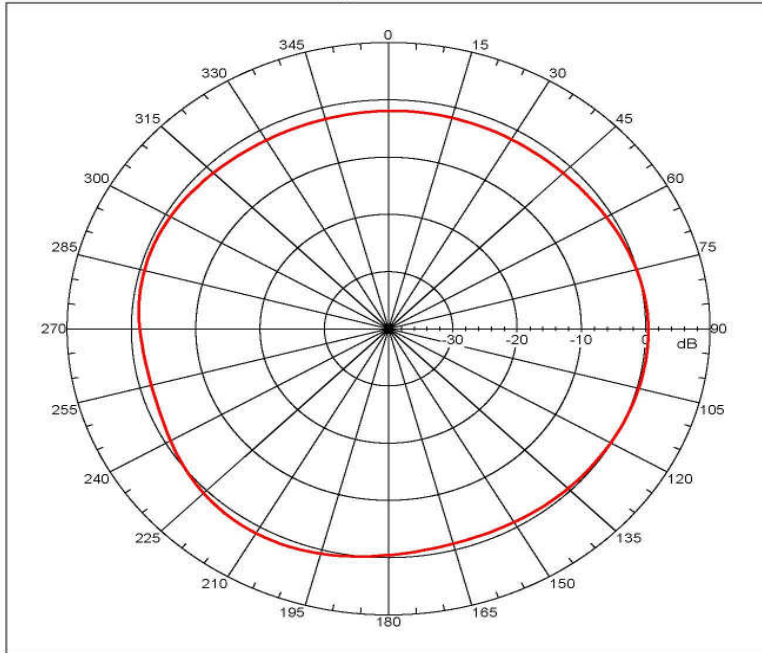

```

Far-field amplitude, Spherical: Linear, TSU = 0.000 deg
Gain = 1.2519 dBi
Max far-field (global) = -40.5808 dB, Max far-field (plot) =
-40.58581 dB
Normalization: Reference, Network offset = 0.000 dB
Vpeak at: -150.00001 deg, Vpeak at: 0.000 deg
Plot centering: On

MA-5 2007/5/9H-Plane cut scan. Feeding cable at bottom side
around H2C been covered by absorber to reduce possible coupling
with AUT.

NSI2000 V4.0.124, Filename:C:\nsi2000\steven\MP-51\8MM\MA-9.nsi
Measurement date/time: 5/9/2007 2:53:22 PM, Filetype: NSI-97
Far-field Cut Analysis:
Avg value: -0.151 dB
-3. dB beam width: Not Found
-5. dB beam width: Not Found
-10. dB beam width: Not Found
Left Sidelobe: Not Found
Right Sidelobe: -1.90 dB at -71.397 deg
Far-field display setup
Azimuth (deg)
Span = 360.00001 deg, Center = 0.000 deg, #pts = 181
Starts = -180.00001 deg, Stop = 180.00001 deg, Delta = 2.000
deg
Elevation (deg)
Center = 0.000 deg, #pts = 1

Selected beam(s) 1 of 4
Beam Frequency Azimuth Elevation Pol
-----
2 0.842 GHz Azimuth Elevation Single-pol
    
```

Far-field amplitude of MA-9.nsi

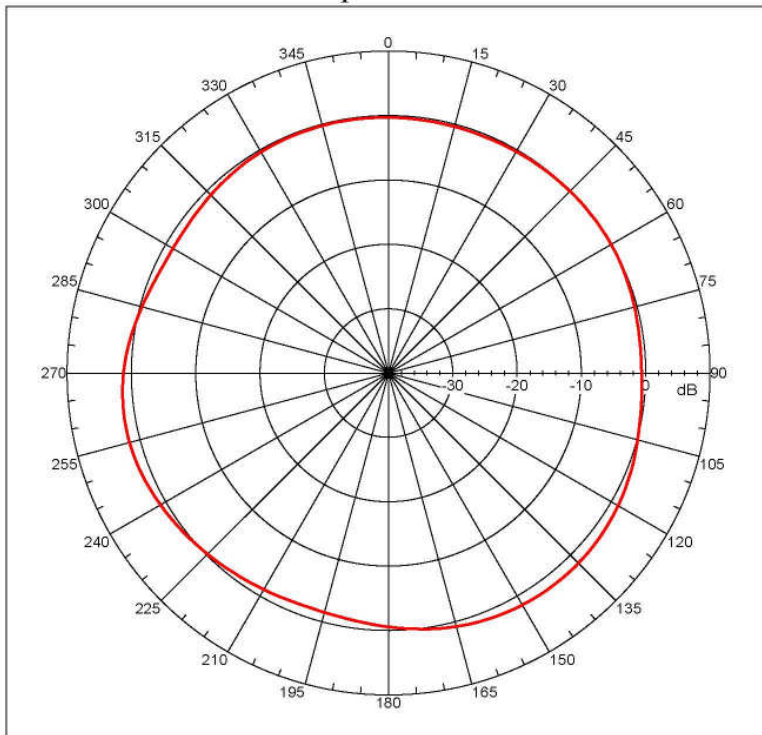

```

Far-field amplitude, Spherical: Linear, TSU = 0.000 deg
Gain = 1.79515 dBi
Max far-field (global) = -40.83452 dB, Max far-field (plot) =
-40.83453 dB
Normalization: Reference, Network offset = 0.000 dB
Vpeak at: 140.000 deg, Vpeak at: 0.000 deg
Plot centering: On

MA-5 2007/5/9H-Plane cut scan. Feeding cable at bottom side
around H2C been covered by absorber to reduce possible coupling
with AUT.

NSI2000 V4.0.124, Filename:C:\nsi2000\steven\MP-51\8MM\MA-9.nsi
Measurement date/time: 5/9/2007 2:53:22 PM, Filetype: NSI-97
Far-field Cut Analysis:
Avg value: 0.071 dB
-3. dB beam width: Not Found
-5. dB beam width: Not Found
-10. dB beam width: Not Found
Left Sidelobe: -0.11 dB at -99.553 deg
Right Sidelobe: Not Found
Far-field display setup
Azimuth (deg)
Span = 360.00001 deg, Center = 0.000 deg, #pts = 181
Starts = -180.00001 deg, Stop = 180.00001 deg, Delta = 2.000
deg
Elevation (deg)
Center = 0.000 deg, #pts = 1

Selected beam(s) 1 of 4
Beam Frequency Azimuth Elevation Pol
-----
2 0.960 GHz Azimuth Elevation Single-pol
    
```

Far-field amplitude of MA-9.nsi

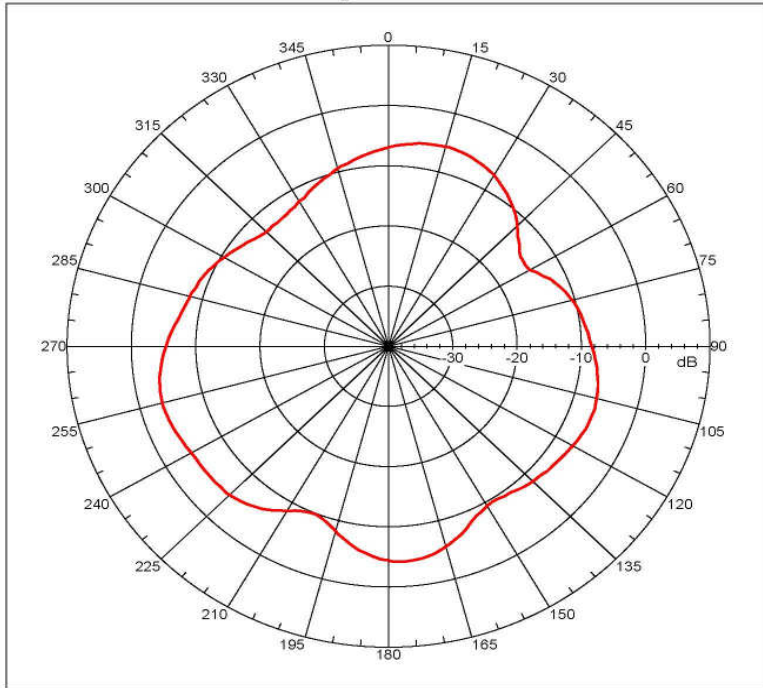

Far-field amplitude, Spherical: Linear, Two - 0.000 deg
 Gain = -3.57571 dB
 Max far-field (global) = -48.94133 dB; Max far-field (plot) = -48.94133 dB
 Normalization: Reference, Network offset = 0.000 dB
 Rpeak at: -106.00001 deg, Vpeak at: 0.000 deg
 Plot centering: On

MA-5 2007/S/9H-Plane cut scan. Feeding cable at bottom side around R/C been covered by absorber to reduce possible coupling with AUT.

NSI2000 V4.0.124, Filename:C:\nsi2000\steven\MP-51 888\MA-9.nsi
 Measurement date/time: 5/9/2007 2:53:22 PM, Filetype: NSI-97
 Far-Field Cut Analysis:
 Avg Value: -7.666 dB
 -3. dB beam width: 90.22 deg
 -6. dB beam width: 90.51 deg
 -10. dB beam width: Not Found
 Left Sidelobe: Not Found
 Right Sidelobe: -2.07 dB at 17.095 deg
 Far-field display setup
 Azimuth (deg)
 Span = 360.00001 deg, Center = 0.000 deg, #pts = 181
 Start = -180.00001 deg, Stop = 180.00001 deg, Delta = 2.000 deg
 Elevation (deg)
 Center = 0.000 deg, #pts = 1

Selected beam(s) 1 of 6
 Beam Frequency Azimuth Elevation Pol

 4 1.710 GHz Azimuth Elevation Single-pol

Far-field amplitude of MA-9.nsi

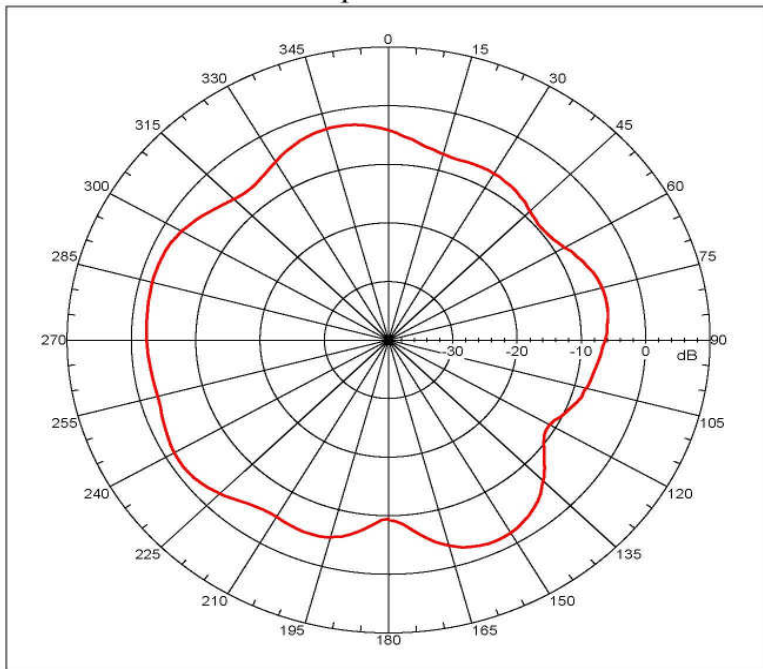

Far-field amplitude, Spherical: Linear, Two - 0.000 deg
 Gain = -1.46166 dB
 Max far-field (global) = -48.82907 dB; Max far-field (plot) = -48.82911 dB
 Normalization: Reference, Network offset = 0.000 dB
 Rpeak at: -124.00001 deg, Vpeak at: 0.000 deg
 Plot centering: On

MA-5 2007/S/9H-Plane cut scan. Feeding cable at bottom side around R/C been covered by absorber to reduce possible coupling with AUT.

NSI2000 V4.0.124, Filename:C:\nsi2000\steven\MP-51 888\MA-9.nsi
 Measurement date/time: 5/9/2007 2:53:22 PM, Filetype: NSI-97
 Far-Field Cut Analysis:
 Avg Value: -4.891 dB
 -3. dB beam width: 89.42 deg
 -6. dB beam width: 207.93 deg
 -10. dB beam width: Not Found
 Left Sidelobe: Not Found
 Right Sidelobe: -1.21 dB at -13.073 deg
 Far-field display setup
 Azimuth (deg)
 Span = 360.00001 deg, Center = 0.000 deg, #pts = 181
 Start = -180.00001 deg, Stop = 180.00001 deg, Delta = 2.000 deg
 Elevation (deg)
 Center = 0.000 deg, #pts = 1

Selected beam(s) 1 of 6
 Beam Frequency Azimuth Elevation Pol

 5 1.900 GHz Azimuth Elevation Single-pol

Far-field amplitude of MA-9.nsi

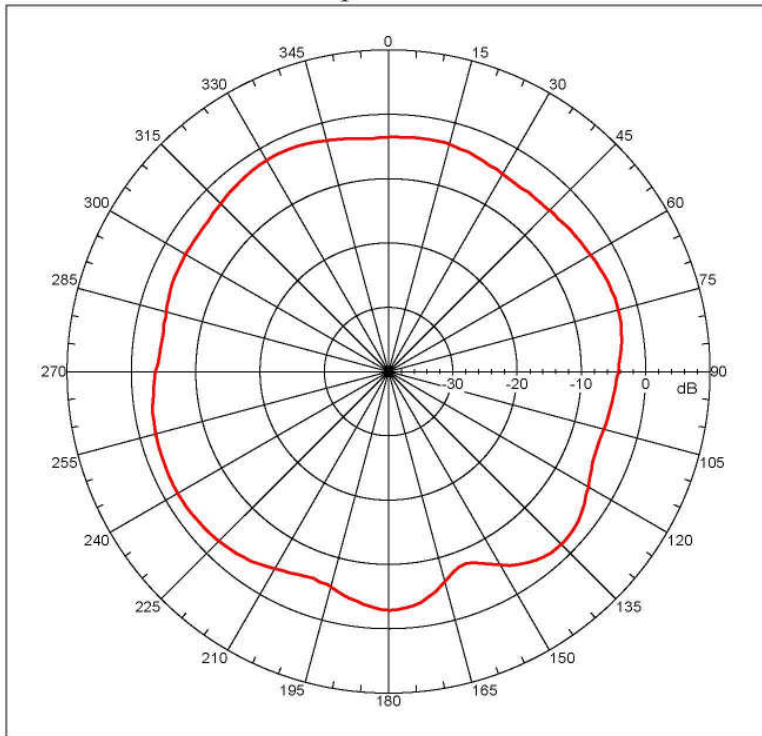

```

Far-field amplitude, Sprincipal: Linear, Tau = 0.000 deg
Gain = -1.98233 dB
Max far-field (plot) = -49.56473 dB; Max far-field (plot) =
-49.5648 dB
Normalization: Reference, Network offset = 0.000 dB
Vpeak at: 123.99999 deg, Vpeak at: 0.000 deg
Plot centering: On

MA-5 2007/5/09-Flare cut scan. Feeding cable at bottom side
around RMC been covered by absorber to reduce possible coupling
with AUT.

NSI2000 V4.0.1E4, Filename: C:\nsi2000\steven\MP-51 8888\MA-9.nsi
Measurement date/time: 5/9/2007 2:53:22 PM, Filetype: NSI-97
Far-field Cut Analysis:
Avg value: -3.684 dB
-3. dB beam width: 33.83 deg
-6. dB beam width: Not Found
-10. dB beam width: Not Found
Left Sidelobe: -0.97 dB at 73.408 deg
Right Sidelobe: Not Found
Far-field display setup
Azimuth (deg)
Span = 360.00001 deg, Center = 0.000 deg, #pts = 181
Start = -180.00001 deg, Stop = 180.00001 deg, Delta = 2.000
deg
Elevation (deg)
Center = 0.000 deg, #pts = 1

Selected beam(s) 1 of 6
Beam Frequency Azimuth Elevation Pol
-----
6 2.170 GHz Azimuth Elevation Single-pol
    
```